

Welcome to



Calibre® would like to take this opportunity to introduce itself to you.

Since beginning business, our company goal has always been simple: “To provide our commercial customers quality products that are delivered in a timely manner, and of exceptional value.”

We believe there are basic values from which a company must operate that dictate its daily actions, decision-making, and guide its future. Our company’s values determine the caliber of employees we hire, and our employees determine the strength of the relationships we build with our customers. The quality, long-term relationships we build with our employees and with our commercial customers are important elements for our future.

Why the name **Calibre** you might ask? Calibre is a word that denotes a high degree of distinction, quality, strength, and value. It is a word that very specifically is meant to assure our customers that you are aligning yourself with a supplier of integrity that stands behind its people, and its product. Most importantly, Calibre is a company that will partner with you for a strong and lasting business relationship built on trust and principle. Calibre is a supplier you can trust and a supplier that will guarantee to serve you well, now and going forward.

We have a commercial website that offers not only our product line, but also gives you some insight into the people behind Calibre. Our website also offers many fine tools to help you better understand some product specific nuances and will assist in your decision making choices.

We sincerely look forward to hearing from you, and would welcome any inquiries you may have.

John Linder

John Linder

Tony Gonzales

Tony Gonzales



Terms & Conditions

- TERMS:** Standard C.O.D. With credit approval, Strict Net 30 days from date of invoice.
- PAYMENT POLICY:** Accounts with unpaid invoices exceeding 30 days may be placed on credit hold until past due amount is paid. If account balances exceed unpaid invoices over 60 days, open account status may be rescinded and C.O.D. terms will apply for subsequent invoices.
- MINIMUM CHARGE:** \$30.00 NET.
- RETURNED CHECKS:** The \$30.00 bank NFS charge will be added for checks returned. Payment terms will be "Cash in Advance" thereafter.
- PRICING:** All prices are subject to pricing prevailing at the date order is received, and are subject to change and correction without notice. State and local taxes, if any, are to be the responsibility of the customer.
- SHIPMENTS:** F.O.B. Our warehouse and are the property of the purchaser enroute.
- FREIGHT:** Freight will be prepaid on 300 pounds or more by the carrier of our choice within the continental United States, unless prior arrangements have been made.
- RETURNED GOODS:** A Returned Goods Authorization (RGA) must be issued before returning any material. Material thus returned shall be freight prepaid and subject to inspection with charges made for reconditioning as needed. A 25% re-stocking fee will be assessed to all non-defective returns.
- ORDERS:** Accepted contingent upon strikes, fires, delay of carriers or other causes beyond the control of the Company.
- CLAIMS:** All claims must be reported to the Company within fifteen days of receipt of the merchandise. Please notify us promptly of any shipment or invoice discrepancy.



LIMITED WARRANTY

Effective May 1, 2006

CALIBRE® products purchased after May 1, 2006 are warranted by Calibre® Door Closers, Inc. to the original purchaser from the date of purchase in accordance with the following warranty schedule:

- OVERHEAD CONCEALED DOOR CLOSERS5 Years**
- SURFACE APPLIED DOOR CLOSERS5 Years**
- DOOR HARDWARE PRODUCTS2 Years**

Calibre® Products are warranted against defects in workmanship and/or material only. They will be replaced with brand-new products at no charge with return postage or freight prepaid by Calibre® Door Closers, Inc. No claims for damage incurred or work done thereon will be allowed, or for liability for incidental or consequential damages arising from defective parts, nor do we assume any responsibility for failure, breakage or cost which results from abuse, abnormal use, misuse, improper installation, negligence or accident.

This warranty gives you specific legal rights, and you may also have other rights, which vary from state to state.





[Overhead Concealed Door Closers](#)

[Surface Mounted Door Closers](#)

[Storefront Door Hardware](#)

[Panic Exit Devices](#)

[List Price Sheets](#)

Standard Overhead Concealed Closers Hydraulic Door Closers

CA1100 OHC Series



FEATURES

- Underwriters' Laboratories Inc. Listed for units without hold open feature. UL10C for positive pressure and certified to conform to UBC 7.2 (1997) BS476 for Fire Safety.
- **Center Hung Door Application :**
Double or Single Acting (applied door stop renders unit Single Acting). Adjustable 'S' type side loading or 'A' type, 'K' type, and 'PT' type end loading arms are available for center pivoted door applications.
- **Offset Hung Door Application :**
Single Acting Offset 'JO' and 'VO' type top arms are available for butt hung or offset pivoted applications.

DOOR CLOSER FUNCTIONS

- Built-in positive Back Stop and Hold-Open positions are available:

YKK-API H6200 Series (Unit Body Only)

| Model Number | Function |
|---------------------------------|-------------------------------|
| 1100-B-1130 YKK-H6209 | 105° Back Stop with Hold-Open |
| 110-B-1131 YKK-H6210 | 105° Back Stop -no Hold-Open |
| 1100-B-1132 YKK-H6211 | 90° Back Stop with Hold-Open |
| 1100-B-1133 YKK H6212 | 90° Back Stop -no Hold-Open |

Center Hung Doors : Complete units for aluminum doors and frames are furnished with top arm assembly ('S' side loading, 'A', 'K', or 'PT' end loading), adjustable dual purpose CA3010-DP bottom pivot set for floor or threshold mounting (side or end loading), and CA3010-FS anchor set with all fasteners.

'S' type side loading top arm, CA3010-DP adjustable dual purpose pivot set, and the CA3010-FS anchor set will be furnished unless otherwise specified by the customer.

'A' type, 'K' type or 'PT' type end loading, and 'JO' or 'VO' type offset arms are optional, but must be specified.

- Standard Fixed spring tensions available:
Medium

For optional ADA, Light, and Heavy spring tensions see CA2200 Series and CA6900 Series door closers.

- **Dual Speed Control Valves :**
Closing and Latching speeds controlled by separate regulating valves, fully adjustable after installation.
- Adjustable CA3010-DP dual purpose radial ball-bearing bottom pivot set is provided for floor or threshold mounted (Side or End Loading) center pivoted installation. CA3010-G and CA3010-GE bottom pivot sets are optional, and must be ordered separately.
- Universal application. Non-handed for left or right door application.
- Installs in an aluminum storefront header or transom as small as 1-3/4" x 4"
- Positive cam centering for alignment and to hold door closed against normal wind or draft conditions.
- Stable hydraulic door check fluid for any climatic operation and provides constant lubrication.



Offset Hung Doors : Complete units for offset pivoted or butt hung aluminum doors and frames are furnished with a 'JO' or 'VO' type offset arm and CA3010-FS anchor set with all fasteners. (Offset pivots or butt hinges not included. Note: Top Door Stop / Arm Cover by others).

CLOSER OVERVIEW (CA1100 SERIES)

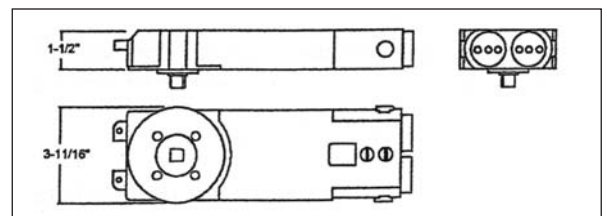

OHC CLOSER DOOR SIZE CHART AND SCHEDULE OF MODELS & TYPES

| DOOR SIZE | SPRING TENSION | TYPE FUNCTION | "S" "A" "K" OR "PT" ARM | "JO" OR "VO" OFFSET ARM |
|-----------------------|----------------|--|------------------------------|--|
| From 31" to 41" X 96" | MEDIUM SPRINGS | 105° Back Stop with Hold-Open 105° Back Stop -no Hold-Open 90° Back Stop with Hold-Open 90° Back Stop -no Hold-Open | 1130 1131 1132 1133 | 1130 x JO or VO 1131 x JO or VO 1132 x JO or VO 1133 x JO or VO |

NOTE:

Doors of sizes over the schedule, or excessive weight, or doors subject to severe wind or draft conditions, or abusive usage, may require the next stronger spring tension model closer.

SPECIFY:

Door Closer Model Number and type of Top Arm, Anchor Set, and / or Bottom Pivot Set.











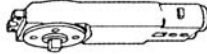

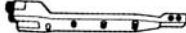
SPECIFY FINISH:

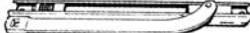
For CA3010-JO or the CA3020-VO Offset Arms:
AL - Aluminum
DU - Storefront Bronze

WARRANTY:

Refer to inside of the Catalog Front cover page.

CA1100 SERIES PARTS and ACCESSORIES

| Description | | Part Number |
|---|--|-------------|
| Unit Body Only (Specify: Spring Tension, Type & Function) |  | CA1100-B |
| "S" Type Side Loading Top Arm Assembly (1/2" Depth Top Rail) |  | CA3010-S |
| "A" Type End Loading Top Arm Assembly (1" Depth Top Rail) |  | CA3010-A |
| "K" Type End Loading Top Arm Assembly (5/8" Depth Top Rail) |  | CA3010-K |
| "PT" Type End Loading Top Arm Assembly (7/8" Depth Top Rail) |  | CA3010-PT |
| "JO" Type Offset Top Arm Assembly (Mortised Type, Cut down into 9/16" Depth Top Rail) |  | CA3010-JO |
| "VO" Type Offset Top Arm Assembly (Surface Type, Requires 7/8" Depth Top Rail) |  | CA3020-VO |
| Anchor Set (Standard - for Snap together Header) |  | CA3010-FS |
| Anchor Set (Optional - for Full tube Cut Away Header) |  | CA3010-FK |
| Corner Anchor Clip ("F" Clip Only) |  | CA3010-F |
| Adjustable Dual Purpose Bottom Pivot Set (Standard) |  | CA3010-DP |
| Adjustable Floor Mount Bottom Pivot Set (Optional) |  | CA3010-G |
| Adjustable Threshold Mount Bottom Pivot Set (Optional) |  | CA3010-GE |

CA1100-B SERIES DOOR CLOSER COMPARISON CHART

| Calibre® CA1100 Series | Global TC7000 | Dromatic 100 Series | International 200 Series | Rixon 608 | CRL 7000 Series | Ryobi 30 Series |
|------------------------|---------------|---------------------|--------------------------|-----------|-----------------|-----------------|
|------------------------|---------------|---------------------|--------------------------|-----------|-----------------|-----------------|



1481 North Main Street Orange, CA 92867-3403 U.S.A.
TEL: 714/633-5100 • Toll Free: 800/560-0012 • FAX: 714/633-5102

Overhead Concealed Closers Hydraulic Door Closers

CA1100-20 OHC Series Extended Spindle Closers



FEATURES

- For Use with Heavy Tempered All Glass Doors.
- Longer 3/4" (19.0 mm) Spindle for deeper Arm penetration and a more secure installation for added door support.
- Complies with ANSI A156.4-2008, and conforms to UL10C for positive pressure and UBC 7.2 (1997) BS476 for Fire Safety for units without hold-open feature.
- **Center Hung Door Application :**
Double or Single Acting (applied door stop renders unit Single Acting). Adjustable 'A' type (CA3010-A) End Loading top arm assembly available for 1" depth, full length, top door rail.
- Optional adjustable shortened 'A' type (CA3010-A-MOD) End Loading top arm assembly available for shorter top door rail, and patch fitting applications.

DOOR CLOSER FUNCTIONS

- **Built-in positive Back Stop and Hold-Open positions are available :**
 - 105° Back Stop with Hold-Open
 - 105° Back Stop -no Hold-Open
 - 90° Back Stop with Hold-Open
 - 90° Back Stop -no Hold-Open

- Handicap (ADA) spring tension and opening force compliancy may be better achieved by the use of the Calibre 3300-20 Series Adjustable Spring Tension door closers.
- **Standard Fixed Spring tensions available :**
 - Medium (RD) Spring Tension
 - Heavy Spring Tension
- **Dual Speed Control Valves :**
Closing and Latching speeds controlled by separate regulating valves, fully adjustable after installation.
- Adjustable CA3010-DP Heavy Duty dual purpose radial ball-bearing bottom pivot set is provided for floor or for threshold mounted center pivoted installation.
- Universal application. Non-handed for left or right hand door application.
- Unit Body installs in an aluminum storefront header or transom as small as 1-3/4" x 4".
- Positive cam centering for alignment and to hold door closed against normal wind or draft conditions.
- Stable hydraulic door check fluid for any climatic operation and provides constant lubrication.

Center Hung Doors : Units may be purchased as Unit Body Only for retrofit and replacement applications. Complete units for All Glass Door application are furnished with CA3010-FS Standard Anchor Set, the CA3010-DP Bottom Pivot Set, and the CA3010-A End Load top arm assembly. The optional CA3010-A-MOD shortened End Load top arm assembly must be ordered separately.

CLOSER OVERVIEW (CA1100-20 SERIES)

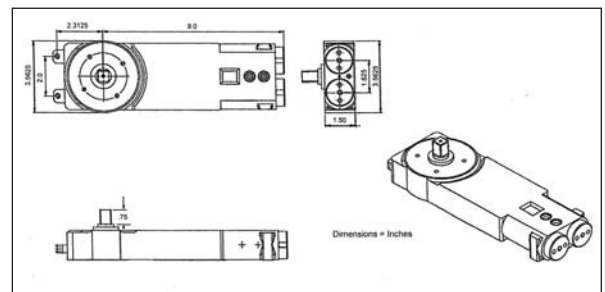

OHC CLOSER DOOR SIZE CHART AND SCHEDULE OF MODELS & TYPES

| DOOR SIZE | SPRING TENSION | TYPE FUNCTION | MODEL NUMBER |
|-----------------|----------------|-------------------------------|--------------|
| From 31" to 41" | Medium | 105° Back Stop with Hold-Open | 1130-20 |
| X | Medium | 105° Back Stop -no Hold-Open | 1131-20 |
| 96" | Medium | 90° Back Stop with Hold-Open | 1132-20 |
| | Medium | 90° Back Stop -no Hold-Open | 1133-20 |
| From 42" to 48" | Heavy | 105° Back Stop with Hold-Open | 1140-20 |
| X | Heavy | 105° Back Stop -no Hold-Open | 1141-20 |
| 96" | Heavy | 90° Back Stop with Hold-Open | 1142-20 |
| | Heavy | 90° Back Stop -no Hold-Open | 1143-20 |

NOTE:

Doors of sizes over the schedule, or excessive weight, or doors subject to severe wind or draft conditions, or abusive usage, may require the next stronger spring tension model closer.







SPECIFY:

Door Closer Model Number (see above), Unit Body Only, or Complete Closer Package.

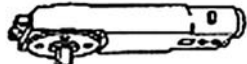
WARRANTY:

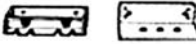
Refer to inside of the Catalog Front cover page.

CA1100-20 SERIES PARTS and ACCESSORIES

| Description | | Part Number |
|---|--|--------------|
| Unit Body Only (Specify: Spring Tension, Type & Function) |  | CA1100-20 |
| "A" Type End Loading Top Arm Assembly (1" Depth Top Rail) |  | CA3010-A |
| "A" Short Type End Loading Top Arm Assembly |  | CA3010-A-MOD |
| Anchor Set (Standard - for Snap together Header) |  | CA3010-FS |
| Anchor Set (Optional - for Full Tube Cut Away Header) |  | CA3010-FK |
| Corner Anchor Clip ("F" Clip Only) |  | CA3010-F |
| Adjustable Dual Purpose Bottom Pivot Set (Standard) |  | CA3010-DP |

Standard Overhead Concealed Closers Hydraulic Door Closers

CA2200 OHC Series



FEATURES

- Underwriters' Laboratories Inc. Listed for units without hold open feature. UL10C for positive pressure and certified to conform to UBC 7.2 (1997) BS476 for Fire Safety.
- **Center Hung Door Application :**
Double or Single Acting (applied door stop renders unit Single Acting). Adjustable 'S' type side loading or 'A' type, 'K' type, and 'PT' type end loading arms are available for center pivoted door applications.
- **Offset Hung Door Application :**
Single Acting Offset 'JO' and 'VO' type top arms are available for butt hung or offset pivoted applications.

DOOR CLOSER FUNCTIONS

- Built-in positive Back Stop and Hold-Open positions are available:
 - 105° Back Stop with Hold-Open
 - 105° Back Stop -no Hold-Open
 - 90° Back Stop with Hold-Open
 - 90° Back Stop -no Hold-Open
- Handicap (ADA) spring tensions available for use on center pivoted door applications :



5.0 lb. Opening Force (Center Hung door)
8.5 lb. Opening Force (Center Hung door)

- Standard Fixed spring tensions available:
 - Light
 - Medium
 - Heavy
- **Dual Speed Control Valves :**
Closing and Latching speeds controlled by separate regulating valves, fully adjustable after installation.
- Adjustable CA3010-DP dual purpose radial ball-bearing bottom pivot set is provided for floor or threshold mounted (Side or End Loading) center pivoted installation. CA3010-G and CA3010-GE bottom pivot sets are optional, and must be ordered separately.
- Universal application. Non-handed for left or right door application.
- Installs in an aluminum storefront header or transom as small as 1-3/4" x 4"
- Positive cam centering for alignment and to hold door closed against normal wind or draft conditions.
- Stable hydraulic door check fluid for any climatic operation and provides constant lubrication.

ADA Opening Force Requirements

Caution: Any manual door closer, installed and adjusted based on ADA or other reduced opening force requirements may not provide sufficient power to reliably close and latch the door.



Center Hung Doors : Complete units for aluminum doors and frames are furnished with top arm assembly ('S' side loading, 'A', 'K', or 'PT' end loading), adjustable dual purpose CA3010-DP bottom pivot set for floor or threshold mounting (side or end loading), and CA3010-FS anchor set with all fasteners.

'S' type side loading top arm, CA3010-DP adjustable dual purpose pivot set, and the CA3010-FS anchor set will be furnished unless otherwise specified by the customer.

'A' type, 'K' type or 'PT' type end loading, and 'JO' or 'VO' type offset arms are optional, but must be specified.

Offset Hung Doors : Complete units for offset pivoted or butt hung aluminum doors and frames are furnished with a 'JO' or 'VO' type offset arm and CA3010-FS anchor set with all fasteners. (Offset pivots or butt hinges not included. Note: Top Door Stop / Arm Cover by others).

CLOSER OVERVIEW (CA2200 SERIES)

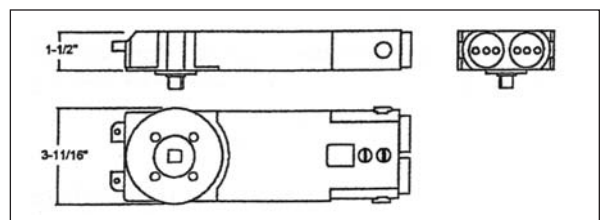

OHC CLOSER DOOR SIZE CHART AND SCHEDULE OF MODELS & TYPES

NOTE:

Doors of sizes over the schedule, or excessive weight, or doors subject to severe wind or draft conditions, or abusive usage, may require the next stronger spring tension model closer.

SPECIFY:



Door Closer Model Number and type of Top Arm, Anchor Set, and / or Bottom Pivot Set.

SPECIFY FINISH:









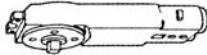

For CA3010-JO or the CA3020-VO Offset Arms:
AL - Aluminum
DU - Storefront Bronze

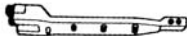
WARRANTY:

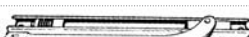
Refer to inside of the Catalog Front cover page.

| DOOR SIZE | SPRING TENSION | TYPE FUNCTION | "S" "A" "K" OR "PT" ARM | "JO" OR "VO" OFFSET ARM |
|-----------------------------|--|-------------------------------|-------------------------|-------------------------|
| From 36" to 48" X 96" | ADA 5 lb. HANDICAP SPRINGS  | 105° Back Stop with Hold-Open | 2200 | N/A |
| | | 105° Back Stop -no Hold-Open | 2201 | N/A |
| | | 90° Back Stop with Hold-Open | 2202 | N/A |
| | | 90° Back Stop -no Hold-Open | 2203 | N/A |
| From 36" to 48" X 96" | ADA 8-1/2 lb. HANDICAP SPRINGS  | 105° Back Stop with Hold-Open | 2210 | N/A |
| | | 105° Back Stop -no Hold-Open | 2211 | N/A |
| | | 90° Back Stop with Hold-Open | 2212 | N/A |
| | | 90° Back Stop -no Hold-Open | 2213 | N/A |
| Up to 30" X 96" | LIGHT SPRINGS | 105° Back Stop with Hold-Open | 2220 | 2220 x JO or VO |
| | | 105° Back Stop -no Hold-Open | 2221 | 2221 x JO or VO |
| | | 90° Back Stop with Hold-Open | 2222 | 2222 x JO or VO |
| | | 90° Back Stop -no Hold-Open | 2223 | 2223 x JO or VO |
| 31" to 41" X 96" | MEDIUM SPRINGS | 105° Back Stop with Hold-Open | 2230 | 2230 x JO or VO |
| | | 105° Back Stop -no Hold-Open | 2231 | 2231 x JO or VO |
| | | 90° Back Stop with Hold-Open | 2232 | 2232 x JO or VO |
| | | 90° Back Stop -no Hold-Open | 2233 | 2233 x JO or VO |
| 42" to 48" X 96" | HEAVY SPRINGS | 105° Back Stop with Hold-Open | 2240 | 2240 x JO or VO |
| | | 105° Back Stop -no Hold-Open | 2241 | 2241 x JO or VO |
| | | 90° Back Stop with Hold-Open | 2242 | 2242 x JO or VO |
| | | 90° Back Stop -no Hold-Open | 2243 | 2243 x JO or VO |

CA2200 SERIES PARTS and ACCESSORIES

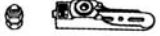
| Description | | Part Number |
|---|--|-------------|
| Unit Body Only (Specify: Spring Tension, Type & Function) |  | CA2200-B |
| "S" Type Side Loading Top Arm Assembly (1/2" Depth Top Rail) |  | CA3010-S |
| "A" Type End Loading Top Arm Assembly (1" Depth Top Rail) |  | CA3010-A |
| "K" Type End Loading Top Arm Assembly (5/8" Depth Top Rail) |  | CA3010-K |
| "PT" Type End Loading Top Arm Assembly (7/8" Depth Top Rail) |  | CA3010-PT |
| "JO" Type Offset Top Arm Assembly (Mortised Type, Cut down into 9/16" Depth Top Rail) |  | CA3010-JO |
| "VO" Type Offset Top Arm Assembly (Surface Type, Requires 7/8" Depth Top Rail) |  | CA3020-VO |
| Anchor Set (Standard - for Snap together Header) |  | CA3010-FS |
| Anchor Set (Optional - for Full tube Cut Away Header) |  | CA3010-FK |
| Corner Anchor Clip ("F" Clip Only) |  | CA3010-F |
| Adjustable Dual Purpose Bottom Pivot Set (Standard) |  | CA3010-DP |
| Adjustable Floor Mount Bottom Pivot Set (Optional) |  | CA3010-G |
| Adjustable Threshold Mount Bottom Pivot Set (Optional) |  | CA3010-GE |



1481 North Main Street Orange, CA 92867-3403 U.S.A.
TEL: 714/633-5100 • Toll Free: 800/560-0012 • FAX: 714/633-5102

Adjustable Spring Tension (ADA) Overhead Concealed Closers Hydraulic Door Closers

CA3300 OHC Series



Models CA3301, CA3302, CA3303
130° Back Stop with 105° Hold-Open
130° Back Stop with 90° Hold-Open
130° Back Stop with No Hold-Open



FEATURES

- Handicap (ADA) multi-sized closers with adjustable spring power for a range of sizes after installation.
- Underwriters' Laboratories Inc. Listed for units without hold open feature. UL10C for positive pressure and certified to conform to UBC 7.2 (1997) BS476 for Fire Safety.
- **Center Hung Door Application :**
Double or Single Acting (applied door stop renders unit Single Acting). Adjustable 'S' type side loading or 'A' type, 'K' type, and 'PT' type end loading arms are available for center pivoted door applications.
- **Offset Hung Door Application:**
Single Acting Offset 'JO' and 'VO' type top arms are available for butt hung or offset pivoted applications. Note : Offset arm application geometry increases the effective spring tension in some instances thereby possibly exceeding the 5 lb. and 8-1/2 lb. Opening Force requirements.

DOOR CLOSER FUNCTIONS

- **Built-in positive Back Stop and Hold-Open positions. are available :**

Models CA3310, CA3311, CA3312, CA3313



105° Back Stop with Hold-Open
105° Back Stop -no Hold-Open
90° Back Stop with Hold-Open
90° Back Stop -no Hold-Open



- **Dual Speed Control Valves :**
Closing and Latching speeds controlled by separate regulating valves, fully adjustable after installation.
- Adjustable CA3010-DP dual purpose radial ball-bearing bottom pivot set is provided for floor or threshold mounted (Side or End Loading) center pivoted installation. CA3010-G and CA3010-GE bottom pivot sets are optional, and must be ordered separately.
- Universal application. Non-handed for left or right door application.
- Installs in an aluminum storefront header or transom as small as 1-3/4" x 4"
- Positive cam centering for alignment and to hold door closed against normal wind or draft conditions.
- Stable hydraulic door check fluid for any climatic operation and provides constant lubrication.
- The 3300-20 Series is the standard 3300 Series OHC door closer assembled with an Extended Spindle Shaft (17/64" longer than standard).

Center Hung Doors : Complete units for aluminum doors and frames are furnished with top arm assembly ('S' side loading, 'A', 'K', or 'PT' end loading), adjustable dual purpose CA3010-DP bottom pivot set for floor or threshold mounting (side or end loading), and CA3010-FS anchor set with all fasteners.

'S' type side loading top arm, CA3010-DP adjustable dual purpose pivot set, and the CA3010-FS anchor set will be furnished unless otherwise specified by the customer.

'A' type, 'K' type or 'PT' type end loading, and 'JO' or 'VO' type offset arms are optional, but must be specified.

ADA Opening Force Requirements

Caution: Any manual door closer, installed and adjusted based on ADA or other reduced opening force requirements may not provide sufficient power to reliably close and latch the door.



Offset Hung Doors : Complete units for offset pivoted or butt hung aluminum doors and frames are furnished with a 'JO' or 'VO' type offset arm and CA3010-FS anchor set with all fasteners. (Offset pivots or butt hinges not included. Note: Top Door Stop / Arm Cover by others).

CLOSER OVERVIEW (CA3300 SERIES)

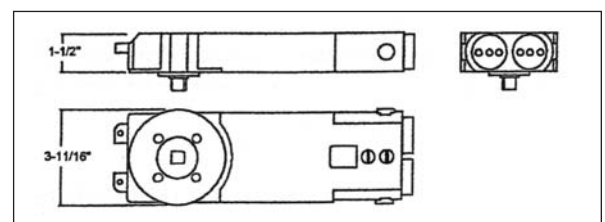

OHC CLOSER DOOR SIZE CHART AND SCHEDULE OF MODELS & TYPES

| DOOR SIZE | SPRING TENSION | TYPE FUNCTION | "S" "A" "K" OR "PT" ARM | "JO" OR "VO" OFFSET ARM |
|-----------------------|--------------------------------|------------------------------------|-------------------------|-------------------------|
| From 36" to 48" X 96" | ADA 5 lb. HANDICAP SPRINGS | 130° Back Stop with 105° Hold-Open | 3301 | N/A |
| | | 130° Back Stop with 90° Hold-Open | 3302 | N/A |
| | | 130° Back Stop with No Hold-Open | 3303 | N/A |
| From 36" to 48" X 96" | ADA 8-1/2 lb. HANDICAP SPRINGS | 105° Back Stop with Hold-Open | 3310 | N/A |
| | | 105° Back Stop -no Hold-Open | 3311 | N/A |
| | | 90° Back Stop with Hold-Open | 3312 | N/A |
| | | 90° Back Stop -no Hold-Open | 3313 | N/A |

NOTE:

Doors of sizes over the schedule, of excessive weight, or doors subject to severe wind or draft conditions, or abusive usage, refer to the CA2200 Series OHC door closers.

SPECIFY:

Door Closer Model Number and type of Top Arm, Anchor Set, and / or Bottom Pivot Set.







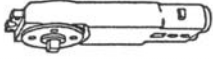
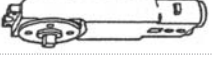

SPECIFY FINISH:

For CA3010-JO or the CA3020-VO Offset Arms:
AL - Aluminum
DU - Storefront Bronze

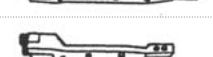
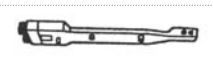
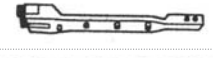
WARRANTY:

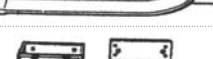
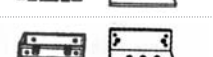
Refer to inside of the Catalog Front cover page.

CA3300 SERIES PARTS and ACCESSORIES

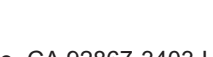
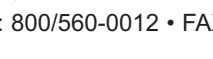
| Description | | Part Number |
|---|--|--------------|
| Unit Body Only (Specify: Spring Tension, Type & Function) |  | CA3300-B |
| Unit Body Only (Specify: Spring Tension, Type & Function) - Extended Spindle |  | CA3300-20-B |
| "S" Type Side Loading Top Arm Assembly (1/2" Depth Top Rail) |  | CA3010-S |
| "A" Type End Loading Top Arm Assembly (1" Depth Top Rail) |  | CA3010-A |
| "A" Type End Loading Top Arm Assembly (Shortened) |  | CA3010-A-MOD |
| "K" Type End Loading Top Arm Assembly (5/8" Depth Top Rail) |  | CA3010-K |
| "PT" Type End Loading Top Arm Assembly (7/8" Depth Top Rail) |  | CA3010-PT |
| "JO" Type Offset Top Arm Assembly (Mortised Type, Cut down into 9/16" Depth Top Rail) |  | CA3010-JO |
| "VO" Type Offset Top Arm Assembly (Surface Type, Requires 7/8" Depth Top Rail) |  | CA3020-VO |
| Anchor Set (Standard - for Snap together Header) |  | CA3010-FS |
| Anchor Set (Optional - for Full tube Cut Away Header) |  | CA3010-FK |
| Corner Anchor Clip ("F" Clip Only) |  | CA3010- F |
| Adjustable Dual Purpose Bottom Pivot Set (Standard) |  | CA3010-DP |
| Adjustable Floor Mount Bottom Pivot Set (Optional) |  | CA3010-G |
| Adjustable Threshold Mount Bottom Pivot Set (Optional) |  | CA3010-GE |



1481 North Main Street Orange, CA 92867-3403 U.S.A.
TEL: 714/633-5100 • Toll Free: 800/560-0012 • FAX: 714/633-5102

Overhead Concealed Closers Hydraulic Door Closers

CA6900 OHC Series



FEATURES

- Independently tested and certified to Meet ANSI A156.4, Grade 1, exceeding the required 2,000,000 independent lab test cycles.
- **Center Hung Door Application :**
Double or Single Acting (applied door stop renders unit Single Acting). Adjustable 'S' type side loading or 'A' type, 'K' type, and 'PT' type end loading arms are available for center pivoted door applications.
- **Offset Hung Door Application :**
Single Acting Offset 'JO' and 'VO' type top arms are available for butt hung or offset pivoted applications.

DOOR CLOSER FUNCTIONS

- **Built-in positive Back Stop and Hold-Open positions are available :**
105° Back Stop with Hold-Open
105° Back Stop -no Hold-Open
90° Back Stop with Hold-Open
- **Handicap (ADA) spring tensions available for use on center pivoted door applications :**



8-1/2 lb. Opening Force (Exterior Door)

ADA Opening Force Requirements

Caution: Any manual door closer, installed and adjusted based on ADA or other reduced opening force requirements may not provide sufficient power to reliably close and latch the door.

- **Standard Fixed spring tensions available :**

Light
Medium
Heavy

- **Dual Speed Control Valves :**
Closing and Latching speeds controlled by separate regulating valves, fully adjustable after installation.
- Adjustable CA3010-DP dual purpose radial ball-bearing bottom pivot set is provided for floor or threshold mounted (Side or End Loading) center pivoted installation. CA3010-G and CA3010-GE bottom pivot sets are optional, and must be ordered separately.
- Universal application. Non-handed for left or right door application.
- Installs in an aluminum storefront header or transom as small as 1-3/4" x 4".
- Positive cam centering for alignment and to hold door closed against normal wind or draft conditions.
- Stable hydraulic door check fluid for any climatic operation and provides constant lubrication.



Center Hung Doors : Complete units for aluminum doors and frames are furnished with top arm assembly ('S' side loading, 'A', 'K', or 'PT' end loading), adjustable dual purpose CA3010-DP bottom pivot set for floor or threshold mounting (side or end loading), and CA3010-FS anchor set with all fasteners.

'S' type side loading top arm, CA3010-DP adjustable dual purpose pivot set, and the CA3010-FS anchor set will be furnished unless otherwise specified by the customer.

'A' type, 'K' type or 'PT' type end loading, and 'JO' or 'VO' type offset arms are optional, but must be specified.

Offset Hung Doors : Complete units for offset pivoted or butt hung aluminum doors and frames are furnished with a 'JO' or 'VO' type offset arm and CA3010-FS anchor set with all fasteners. (Offset pivots or butt hinges not included. Note: Top Door Stop / Arm Cover by others).

CLOSER OVERVIEW (CA6900 SERIES)

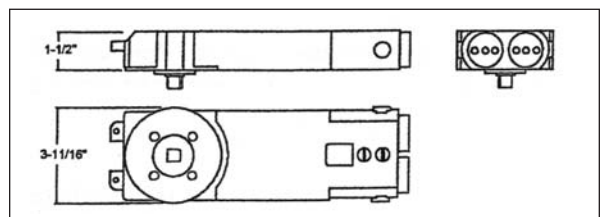

OHC CLOSER DOOR SIZE CHART AND SCHEDULE OF MODELS & TYPES

| DOOR SIZE | SPRING TENSION | TYPE FUNCTION | "S" "A" "K" OR "PT" ARM | "JO" OR "VO" OFFSET ARM |
|-----------------------|--------------------------------|-------------------------------|-------------------------|-------------------------|
| From 36" to 48" X 96" | ADA 8-1/2 lb. HANDICAP SPRINGS | 105° Back Stop with Hold-Open | 6910 (050-921) | N/A |
| | | 105° Back Stop -no Hold-Open | 6911 (050-922) | N/A |
| | | 90° Back Stop with Hold-Open | 6912 (050-923) | N/A |
| Up to 30" X 96" | LIGHT SPRINGS | 105° Back Stop with Hold-Open | 6920 (050-924) | 6920 x JO or VO |
| | | 105° Back Stop -no Hold-Open | 6921 (050-925) | 6921 x JO or VO |
| | | 90° Back Stop with Hold-Open | 6922 (050-926) | 6922 x JO or VO |
| 31" to 41" X 96" | MEDIUM SPRINGS | 105° Back Stop with Hold-Open | 6930 (050-927) | 6930 x JO or VO |
| | | 105° Back Stop -no Hold-Open | 6931 (050-928) | 6931 x JO or VO |
| | | 90° Back Stop with Hold-Open | 6932 (050-929) | 6932 x JO or VO |
| 42" to 48" X 96" | HEAVY SPRINGS | 105° Back Stop with Hold-Open | 6940 (050-930) | 6940 x JO or VO |
| | | 105° Back Stop -no Hold-Open | 6941 (050-931) | 6941 x JO or VO |
| | | 90° Back Stop with Hold-Open | 6942 (050-932) | 6942 x JO or VO |

NOTE:

Doors of sizes over the schedule, or excessive weight, or doors subject to severe wind or draft conditions, or abusive usage, may require the next stronger spring tension model closer.

SPECIFY:

Door Closer Model Number and type of Top Arm, Anchor Set, and / or Bottom Pivot Set.











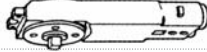

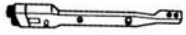
SPECIFY FINISH:

For CA3010-JO or the CA3020-VO Offset Arms:
AL - Aluminum
DU - Storefront Bronze

WARRANTY:

Refer to inside of the Catalog Front cover page.

CA6900 SERIES PARTS and ACCESSORIES

| Description | | Part Number |
|---|--|-------------|
| Unit Body Only (Specify: Spring Tension, Type & Function) |  | CA6900-B |
| "S" Type Side Loading Top Arm Assembly (1/2" Depth Top Rail) |  | CA3010-S |
| "A" Type End Loading Top Arm Assembly (1" Depth Top Rail) |  | CA3010-A |
| "K" Type End Loading Top Arm Assembly (5/8" Depth Top Rail) |  | CA3010-K |
| "PT" Type End Loading Top Arm Assembly (7/8" Depth Top Rail) |  | CA3010-PT |
| "JO" Type Offset Top Arm Assembly (Mortised Type, Cut down into 9/16" Depth Top Rail) |  | CA3010-JO |
| "VO" Type Offset Top Arm Assembly (Surface Type, Requires 7/8" Depth Top Rail) |  | CA3020-VO |
| Anchor Set (Standard - for Snap together Header) |  | CA3010-FS |
| Anchor Set (Optional - for Full tube Cut - Away Header) |  | CA3010-FK |
| Corner Anchor Clip ("F" Clip Only) |  | CA3010-F |
| Adjustable Dual Purpose Bottom Pivot Set (Standard) |  | CA3010-DP |
| Adjustable Floor Mount Bottom Pivot Set (Optional) |  | CA3010-G |
| Adjustable Threshold Mount Bottom Pivot Set (Optional) |  | CA3010-GE |



1481 North Main Street Orange, CA 92867-3403 U.S.A.
TEL: 714/633-5100 • Toll Free: 800/560-0012 • FAX: 714/633-5102



Adjustable Spring Tension (ADA) Hydraulic Door Closers

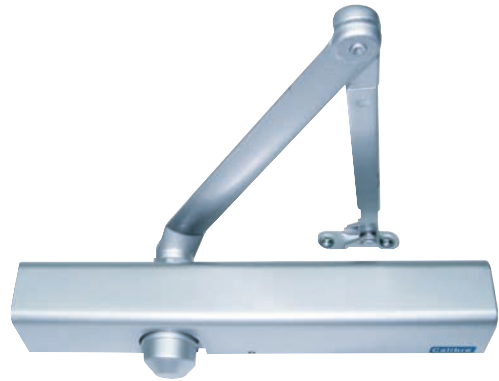

CA1400 Series

FEATURES

- Complies with ANSI A156.4-2008 Grade 1 for Modern Types with Cover C02011, C02021, and C02041, and conforms with the Federal Accessibility Standards (ADA) and ANSI A117.1 (4, 13, 11).
- UL Listed for UL10C for positive pressure and UBC 7.2 (1997) BS476 and Fire Safety, and for use on "A" label fire doors.
- ADA (Handicapped) multi-sized closer with adjustable spring power for a range of sizes from 5 lbs. Opening Force to spring Size 6.
- Universally non-handed and Tri-Packed for Standard, Top Jamb, and Parallel Arm installations (Parallel Arm Bracket included).
- Retrofits existing LCN 1460/1461 Series and similar type door closer installations.

DOOR CLOSER FUNCTIONS

CA1401...5 lb. Opening Force to Size 6. Adjustable Spring power with fully adjustable Back-Check controlled by a separate regulating valve.

ADA Opening Force Requirements

Caution: Any manual door closer, installed and adjusted based on ADA or other reduced opening force requirements may not provide sufficient power to reliably close and latch the door.



Dual Speed Control Valves :

Closing and Latching speeds controlled by separate Regulating valves, fully adjustable after installation.

- Specially formulated stable high viscosity door check fluid for climatic operation in extremes of heat and cold, high flash point, and provides for constant unit lubrication.
- Optional T-Pin Cush (LCN type) hold-open forearm is available, ordered separately as an option.
- Pre-drilled steel mounting plates for most typical door mounting applications.
- Series 1400 furnished with a high impact, non-corrosive Slim Line PVC Dress Cover secured by machine screws.
- TAA Compliant and Meets Buy America Act criteria and requirements.

Attractive Baked Enamel finishes :

- AL - Aluminum
- DU - Storefront Bronze



CLOSER OVERVIEW (Model CA1401)

| | |
|------------------------------------|---------|
| A. Length of Closer w/ Cover | 12-1/4" |
| B. Horizontal Mounting Holes | 7-1/2" |
| C. Vertical Mounting Holes | 1" |
| D. Overall Height | 4-1/2" |
| E. Top of Door to Bottom of Closer | 2-9/16" |
| F. Height of Closer | 2" |
| G. Projection from Door | 2-3/8" |

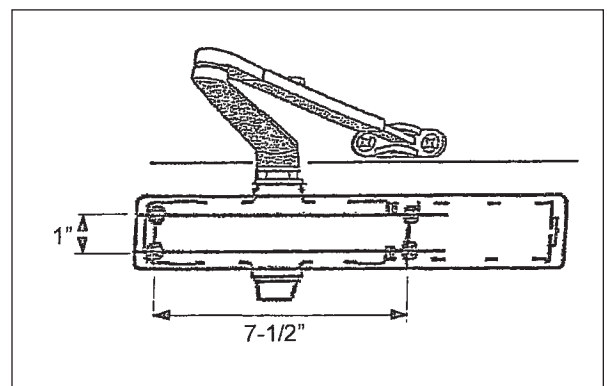

TYPICAL SURFACE MOUNTED DOOR CLOSER INSTALLATIONS (shown with Regular Forearms)

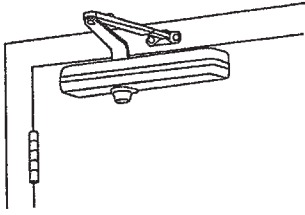

Standard Installation

Door closer mounted on the Door, on the **PULL** side. For installations on top Door Rails of less than 2-3/4", Drop Plate **Part DP-1400-18** is required. Plate requires a 2" minimum height door rail.

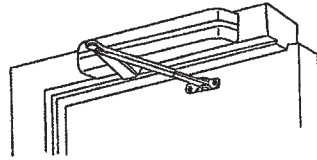

Top Jamb Installation

Door closer mounted on the Header, on the **PUSH** side. For installations on top Door Headers of less than 1-3/4", Drop Plate **Part DP-1400-18** may be required

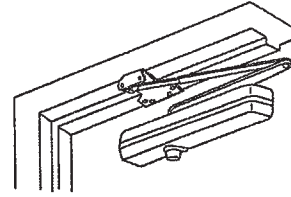

Parallel Arm Installation

Door closer mounted on the Door, on the **PUSH** side. For installations on top Door Rails of less than 4-1/2", (as measured down from the door stop), Drop Plate **Part DP-1400-18PA** is required. Drop plate requires 2" minimum height door rail.

NOTE:

Doors of unusual height or weight, or doors subject to severe wind or draft conditions, or abusive usage, or stack pressure may require additional turns of the hex spring adjustment nut than is indicated on the installation instructions.

SPECIFY:

Closer Model or Part Number.

SPECIFY FINISH:

AL - Aluminum
DU - Storefront Bronze





SPECIFY HANDLING:

Handing is not required for the CA1400 Series door closers or for the assemblies.

WARRANTY:

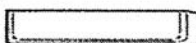
Please refer to the inside of the Catalog front cover page.

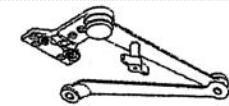
CA1400 SERIES PARTS and ACCESSORIES

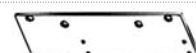
| Description | | Part Number |
|--|--|--------------|
| Complete Closer Package (includes Parallel Bracket) |  | CA1401 |
| PVC Slim Line Dress Cover |  | DC-1400 |
| Complete Regular Arm Assembly |  | RA-1400 |
| Hold-Open Arm Assembly (CNS Type) |  | HOA-1400-CNS |
| Parallel Arm Bracket |  | PA-1400 |
| Flat Drop Plate (For Door/Header Application - see Top of Page) |  | DP-1400-18 |
| Flat Drop Plate (For Parallel Arm Application - see Top of Page) |  | DP-1400-18PA |



1481 North Main Street Orange, CA 92867-3403 U.S.A.

TEL: 714/633-5100 • Toll Free: 800/560-0012 • FAX: 714/633-5102



Adjustable Spring Tension (ADA) Hydraulic Door Closers

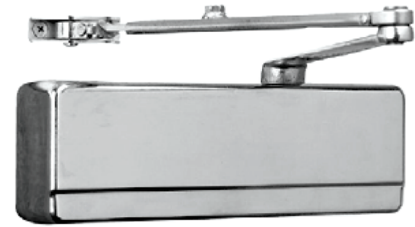

CA2800 Series

FEATURES

- Complies with ANSI A156.4 Grade 1 for Modern Types with Cover C02011, C02021 and C02041, and conforms with the Federal Accessibility Standards (ADA) and with ANSI A117.1 (4,13,11).
- UL Listed for UL10C and UBC 7.2 (1997) for positive pressure fire test, and for use on "A" label fire doors
- ADA (Handicap) multi-sized closer with adjustable spring power for a range of sizes from Size 1 through spring Size 6.
- Universally non-handed and Tri-Packed for Standard, Top Jamb, and Parallel Arm installations (Parallel Arm Bracket Included). Includes heavy duty closer mounting bracket Back Plate for easy installation.
- Retrofits existing Sargent 281 Series closers, as well as the Sargent 250 and 1250 Series door closers.
- TAA Compliant and meets Buy America criteria and requirements

DOOR CLOSER FUNCTIONS

CA2801...Size 1 Opening Force to Size 6. Adjustable Spring Power with fully adjustable Back-Check function controlled by a separate regulating valve.

ADA Opening Force Requirements

Caution: Any manual door closer, including door closers certified by BHMA/ANSI to conform to A156.4, that are installed and adjusted based on ADA or other reduced opening force requirements may not provide sufficient power to reliably close and latch the door.



■ Dual Speed Control Valves :

Closing and Latching speeds controlled by separate regulating valves, adjustable after installation.

- Separate adjustable Back-Check function protects the door and door hardware from damage during the door opening cycle. Back-Check engineered to take effect at 65° to 70° of door opening.

Important Note : The Back-Check should never be used in lieu of a door stop. Using the Back-Check as a door stop can generate internal pressure sufficient to rupture the 'O' ring seals.

HEAVY DUTY CONSTRUCTION

- High quality heat treated structural steel rack and pinion control mechanism with needle bearings for enhanced performance and extended use.
- Heavy duty one piece cast iron door closer body provides superior strength and lasting durability.
- Attractive Baked Enamel finishes :
AL - Aluminum
DU - Storefront Bronze



CLOSER OVERVIEW (Model CA2801)

| | |
|---|--------|
| A. Length of Closer w/ Cover | 12" |
| B. Height of Closer w/ Cover | 4-3/8" |
| C. Projection from Door w/ Cover | 2-1/4" |
| D. Top of Door to Bottom of Closer w/ Cover | 5-1/4" |

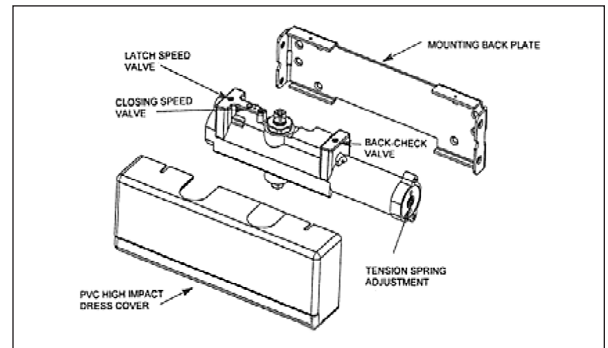

TYPICAL SURFACE MOUNTED DOOR CLOSER INSTALLATIONS (shown with Standard Arm)

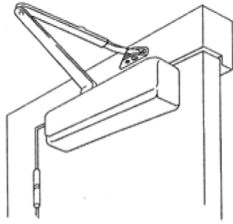

Standard Installation

Door closer mounted on the Door, on the **PULL** side. Arm mounted to face of the door frame. Standard installation is most common and provides maximum door closer control and the full range of spring power adjustment.

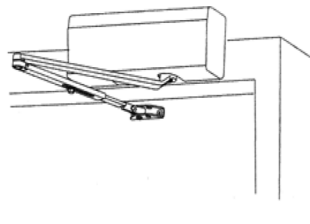

Top Jamb Installation

Door closer mounted on the Header, on the **PUSH** side. Arm shoe is mounted to the push side face of the door. Top Jamb installation is typically used for exterior swing out door application.

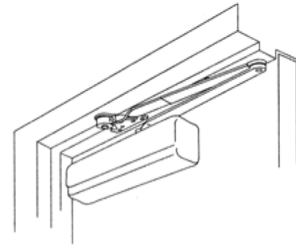

Parallel Arm Installation

Door closer mounted on the Door, on the **PUSH** side. Arm is installed pre-tensioned on a parallel/horizontal plane beneath the door header/transom. Note that the parallel arm installation reduces both the closing power and can limit the degree of the latching adjustment.

NOTE:

Doors of unusual height or weight, or doors subject to severe wind or draft conditions, or abusive usage, may require additional turns of the hex spring adjustment nut than is indicated on the installation instructions.

SPECIFY:

Closer Model or Part Number: CA2801

SPECIFY FINISH:

AL - Aluminum
DU - Storefront Bronze

SPECIFY HANDLING:

Handing is not required for the 2801 Standard "O" type arm assembly.

WARRANTY:

Please refer to the inside of the Catalog front cover page.

CA2800 SERIES PARTS and ACCESSORIES

Description

Part Number

Complete 2801 Closer Package

Includes: Unit Body, Mounting Bracket Plate, PVC Dress Cover, Parallel Arm Bracket, 'O' type Standard Arm Assembly, and the Installation Fasteners for both metal and wood door applications.



CA2801

Flat Drop Plate

For Parallel Arm installation of aluminum framed Storefront Doors



CA2801PA

Adjustable Spring Tension (ADA) Hydraulic Door Closers



CA4000 Series

FEATURES

- Complies with ANSI A156.4 Grade 1.
- Barrier Free Operation to comply with Federal Accessibility Standards (ADA) and ANSI A117.1 (4,13,11).
- Underwriters' Laboratories Inc. Listed. Listed for UL10C for positive pressure and certified to conform to UBC 7.2 (1997) BS476 for Fire Safety.
- ADA (Handicap) multi-sized closer with adjustable spring tension for a range of sizes adjustable after installation from 5 lbs. of Opening Force to spring Size 4.

DOOR CLOSER FUNCTIONS

CA4001...5 lb. Opening Force to Size 4. Adjustable spring power with fully adjustable Back-Check controlled by a separate regulating valve, adjustable after installation.

ADA Opening Force Requirements

Caution: Any manual door closer, installed and adjusted based on ADA or other reduced opening force requirements may not provide sufficient power to reliably close and latch the door.



- **Dual Speed Control Valves :**
Closing and Latching speeds controlled by separate regulating valves, adjustable after installation.
- Universal application. Non-handed for Standard, Top Jamb, or Parallel Arm installation (Parallel Arm Bracket included).
- Rack and pinion control mechanism contained in a high tensile precision die cast aluminum housing.
- Stable hydraulic door check fluid for any climatic operation and provides constant lubrication.
- Furnished with regular arm. Hold-open arm (type 4300 optional). Hold-open arms are adjustable from 100° to 180° of door opening.
- Series CA4000 furnished with high impact molded PVC Dress Cover, which should be used with closer.
- Attractive Baked Enamel finishes :
AL - Aluminum
DU - Storefront Bronze



CA4000 SERIES DOOR CLOSER COMPARISON CHART

| Calibre® CA4000 Series | LCN 4040 / 4041 | International 4400 / 4400CI | Cal Royal CR4041 | Global TC4041 | CRL PR90 |
|---------------------------|--------------------|--------------------------------|---------------------|------------------|-------------|
|---------------------------|--------------------|--------------------------------|---------------------|------------------|-------------|

CLOSER OVERVIEW (Model CA4001)

| | |
|------------------------------------|----------|
| A. Length of Closer w/ Cover | 12-1/4" |
| B. Horizontal Mounting Holes | Shown |
| C. Vertical Mounting Holes | 2-1/4" |
| D. Overall Height | 4-7/8" |
| E. Top of Door to Bottom of Closer | 3-11/16" |
| F. Height of Closer | 3-1/2" |
| G. Projection from Door | 2-1/4" |

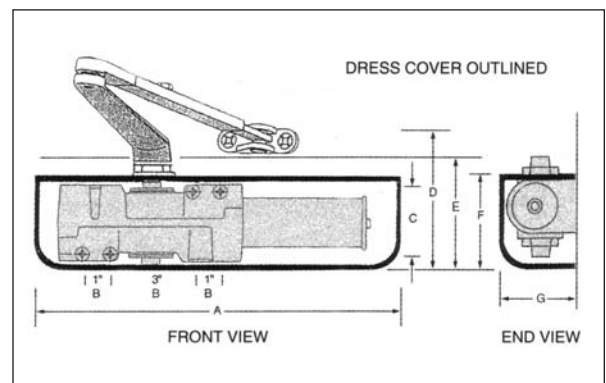

TYPICAL SURFACE MOUNTED DOOR CLOSER INSTALLATIONS (shown with Regular Forearms)

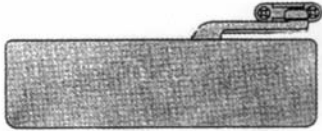

Standard Installation

Door closer mounted on the Door, on the **PULL** side. For installations on top Door Rails of less than 3-3/4", Drop Plate **Part CA4018** is required. Plate requires a 2" minimum height door rail.

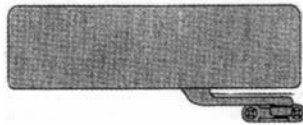

Top Jamb Installation

Door closer mounted on the Header, on the **PUSH** side. For installations on top Door Headers of less than 3-1/2", Drop Plate **Part CA4018J** is required. With the ceiling flush to top of header use **Part CA4018G**. Either Drop plate requires 1-3/4" minimum height header.

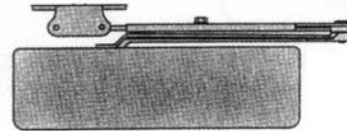

Parallel Arm Installation

Door closer mounted on the Door, on the **PUSH** side. For installations on top Door Rails less than 5-1/2", (as measured down from the door stop), Drop Plate **Part CA4018PA** is required. Drop plate requires 2" minimum height door rail.

NOTE:

Doors of unusual height or weight, or doors subject to severe wind or draft conditions, or abusive usage, may require additional turns of the hex spring adjustment nut than is indicated on the installation instructions.

SPECIFY:

Closer Model or Part Number.

SPECIFY FINISH:

AL - Aluminum
DU - Storefront Bronze



SPECIFY HANDLING:

Handing is not required for the CA4000 arm assemblies.

WARRANTY:

Please refer to the inside of the Catalog front cover page.

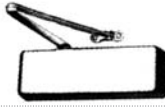
CA4000 SERIES PARTS and ACCESSORIES

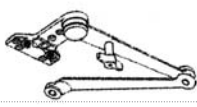
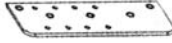
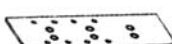
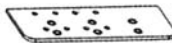
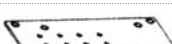
| Description | | Part Number |
|--|---|-------------|
| Complete Closer Package (includes Parallel Bracket) |  | # CA4001 |
| PVC Dress Cover |  | # CA-DC4000 |
| Complete Standard Arm Assembly |  | # CA2000 |
| Hold-Open Arm Assembly |  | # CA4300 |
| Flat Drop Plate (For Door Application - see Top of Page) |  | # CA4018 |
| Flat Drop Plate (For Header Application - see Top of Page) |  | # CA4018J |
| Flat Drop Plate (For Header Application - see Top of Page) |  | # CA4018G |
| Flat Drop Plate (For Door Application - see Top of Page) |  | # CA4018PA |



1481 North Main Street Orange, CA 92867-3403 U.S.A.
TEL: 714/633-5100 • Toll Free: 800/560-0012 • FAX: 714/633-5102



Adjustable Spring Tension (ADA) Hydraulic Door Closers

CA5500 Series



FEATURES

- Complies with ANSI A156.4 Grade 1.
- Barrier Free Operation to comply with Federal Accessibility Standards (ADA) and ANSI A117.1 (4,13,11).
- Underwriters' Laboratories Inc. Listed. Listed for UL10C for positive pressure and certified to conform to UBC 7.2 (1997) BS476 for Fire Safety.
- ADA (Handicap) multi-sized closer with adjustable spring tension for a range of sizes after installation :

DOOR CLOSER FUNCTIONS

CA5501...8 1/2 lb. Opening Force to Size 5.
Adjustable spring power with fully adjustable Back-Check controlled by a separate regulating valve, adjustable after installation.

CA5502...5 lb. Opening Force to Size 4.
Adjustable spring power with Delayed Closing Action controlled by a separate regulating valve, adjustable after installation.

CA5503...5 lb. Opening Force to Size 4.
Adjustable spring power only.

ADA Opening Force Requirements

Caution: Any manual door closer, installed and adjusted based on ADA or other reduced opening force requirements may not provide sufficient power to reliably close and latch the door.



- **Dual Speed Control Valves:**
Closing and Latching speeds controlled by separate regulating valves, adjustable after installation.
- Universal application. Non-handed for Standard, Top Jamb, or Parallel Arm installation.
- Rack and pinion control mechanism contained in a high tensile precision die cast aluminum housing.
- Stable hydraulic door check fluid for any climatic operation and provides constant lubrication.
- Furnished with regular arm. Hold-open and fusible link hold-open arms optional. Hold-open arms are adjustable from 100° to 180° of door opening.
- Series CA5500 furnished with high impact molded PVC Dress Cover (door closer body casting can be used without the Dress Cover, permitting installation on most modern glass and aluminum doors without adaptors).
- Optional Slim-Line PVC Dress Cover (Norton 8300 Type) and Pinion Cap are available.
- Attractive Baked Enamel finishes :
AL - Aluminum
DU - Storefront Bronze



CLOSER OVERVIEW (Models CA5501, CA5502 and CA5503)

| | With Cover | No Cover |
|------------------------------------|------------|-----------|
| A. Length of Closer | 13" | 12-11/16" |
| B. Horizontal Mounting Holes | 12" | 12" |
| C. Vertical Mounting Holes | 3/4" | 3/4" |
| D. Overall Height | 5-1/8" | 5-1/16" |
| E. Top of Door to Bottom of Closer | 3-1/2" | 3-7/16" |
| F. Height of Closer | 3" | 2-7/8" |
| G. Projection from Door | 2-5/16" | 2-3/16" |

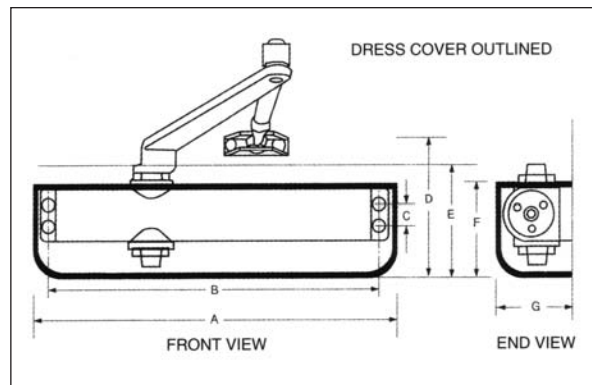

TYPICAL SURFACE MOUNTED DOOR CLOSER INSTALLATIONS (shown with Regular Forearms)

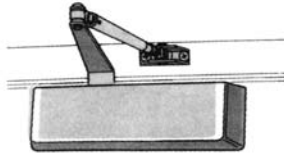

STANDARD

Standard Installation

Door closer mounted on the Door, on the **PULL** side.

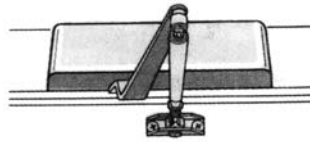

TOP JAMB

Top Jamb Installation

Door closer mounted on the Header, on the **PUSH** side.

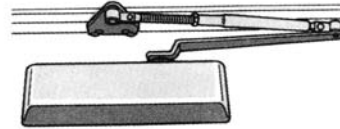

PARALLEL ARM

Parallel Arm Installation

Door closer mounted on the Door, on the **PUSH** side.

SPECIFY DOOR CLOSER MODEL WHEN ORDERING

| | Back-Check | Delayed Closing | Basic | Function |
|---------------------------|----------------|-----------------|----------------|---|
| Door Closers Model Number | 5501 5501-P | 5502 5502-P | 5503 5503-P | Regular Forearm Application Parallel Arm Application |

NOTE:

Doors of unusual height or weight, or doors subject to severe wind or draft conditions, or abusive usage, may require additional turns of the hex spring adjustment nut than is indicated on the installation instructions.

SPECIFY:

Closer Model or Part Number.

SPECIFY FINISH:

AL - Aluminum
DU - Storefront Bronze









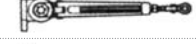

SPECIFY HANDLING:

"LH" OR "RH" for all Fusible Link Hold-Open Forearms.

WARRANTY:

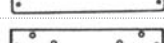
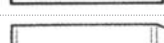
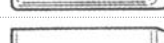
Please refer to the inside of the Catalog front cover page.

CA5500 SERIES PARTS and ACCESSORIES

| Description | | Part Number |
|---|--|---------------|
| Main Arm |  | # CA520 |
| Regular Forearm |  | # CA521 |
| Hold-Open Forearm |  | # CA522 |
| Fusible Link Hold-Open Forearm (Handed LH or RH) |  | # CA523 |
| Top Jamb Forearm Extender |  | # CA514 |
| Parallel Bracket for Regular Forearm |  | # CA525 |
| Parallel Bracket for Hold-Open Forearm |  | # CA526 |
| Flat Drop Plate (for Door Application) |  | # CA5507 |
| Top Jamb Plate (for Header Application) |  | # CA-TJB-5558 |
| PVC Dress Cover (Full Norton 8500 Type) |  | # CA-DC-5500 |
| PVC Dress Cover (Slim-Line Norton 8300 Type) |  | # CA-DC-6000 |
| Thru Bolt and Grommet Nut (Set of 4 each) |  | # CA-TBGN-50 |
| Sex Nut and Bolt Set (1/4-20 x 1.75") (Set of 4 each) |  | # CA-SNB-175 |



1481 North Main Street Orange, CA 92867-3403 U.S.A.

TEL: 714/633-5100 • Toll Free: 800/560-0012 • FAX: 714/633-5102



Standard/Adjustable Back-Check Hydraulic Door Closers

CA6500/CA6800 Series



FEATURES

- Certified ANSI A156.4 Grade 1.
- Underwriters' Laboratories Inc. Listed. Listed for UL10C for positive pressure and certified to conform to UBC 7.2 (1997) BS476 for Fire Safety.
- **Range of Sizes :**
Standard: CA6502, CA6503, CA6504 and CA6505
Back-Check: CA6803, CA6804 and CA6805
- **Dual Speed Control Valves :**
 Closing and Latching speeds controlled by separate regulating valves, fully adjustable after installation.
- CA6800 Series has adjustable Back-Check function controlled by a separate regulating valve, adjustable after installation.
- Universal application. Non-handed for Standard, Top Jamb, or Parallel Arm installation.
- Rack and pinion control mechanism contained in a high tensile precision die cast aluminum housing.
- Stable hydraulic door check fluid for any climatic operation and provides constant lubrication.
- Furnished with regular arm. Hold-open and fusible link hold-open arms optional. Hold-open arms are adjustable from 100° to 180° of door opening.
- CA6500/CA6800 door closers are contained in two body casting sizes. Spring sizes 2 and 3 contained in a Size 3 body casting, and spring sizes 4 and 5 are contained in a Size 4 body casting.
- Attractive Baked Enamel finishes :
 AL - Aluminum
 DU - Storefront Bronze



CLOSER OVERVIEW (SERIES CA6500 and CA6800)

| | Size 2 & 3 | Size 4 & 5 |
|------------------------------------|---------------|---------------|
| A. Length of Closer | 8-7/8" | 9-13/16" |
| B. Horizontal Mounting Holes | 8-3/16" | 9-1/16" |
| C. Vertical Mounting Holes | 3/4" | 3/4" |
| D. Overall Height | 4-21/32" | 4-21/32" |
| E. Top of Door to Bottom of Closer | 2-9/32" | 2-9/32" |
| F. Height of Closer | 1-25/32" | 1-25/32" |
| G. Projection from Door | 2-27/32" | 2-27/32" |

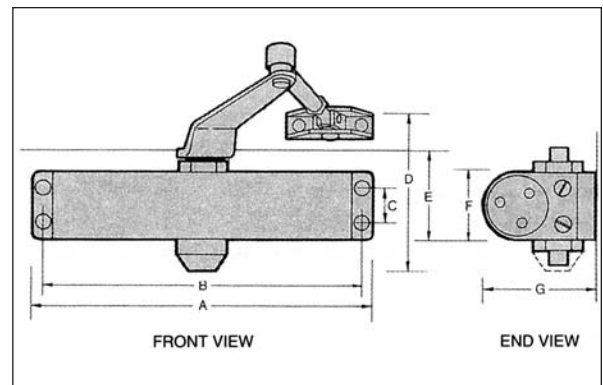

TYPICAL SURFACE MOUNTED DOOR CLOSER INSTALLATIONS (shown with Regular Forearms)

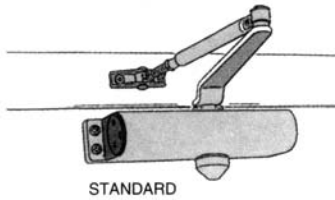

STANDARD

Standard Installation

Door closer mounted on the Door, on the **PULL** side.

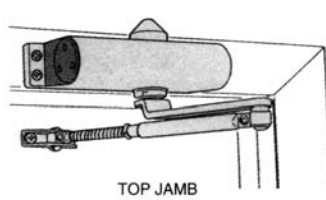

TOP JAMB

Top Jamb Installation

Door closer mounted on the Header, on the **PUSH** side.

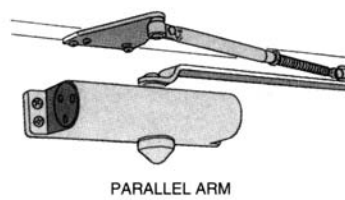

PARALLEL ARM

Parallel Arm Installation

Door closer mounted on the Door, on the **PUSH** side.

SPECIFY DOOR CLOSER MODEL WHEN ORDERING

| INTERIOR Door size | EXTERIOR DOOR SIZE | | MODEL NUMBER | | Function |
|-----------------------|--------------------|----------|--------------|------------|-----------------------------|
| | Swing Out | Swing In | Standard | Back-Check | |
| 36" | 32" | 28" | #6502 | n/a | Regular Forearm Application |
| 32" | 28" | 24" | #6502-P | n/a | Parallel Arm Application |
| 42" | 36" | 32" | #6503 | #6803 | Regular Forearm Application |
| 36" | 32" | 28" | #6503-P | #6803-P | Parallel Arm Application |
| 48" | 42" | 36" | #6504 | #6804 | Regular Forearm Application |
| 42" | 36" | 32" | #6504-P | #6804-P | Parallel Arm Application |
| 54" | 48" | 42" | #6505 | #6805 | Regular Forearm Application |
| 48" | 42" | 36" | #6505-P | #6805-P | Parallel Arm Application |

NOTE:

Doors of unusual height or weight, or doors subject to severe wind or draft conditions, or abusive usage, may require the next larger model door closer than the schedule.

SPECIFY:

Closer Model or Part Number.

SPECIFY FINISH:

AL - Aluminum
DU - Storefront Bronze







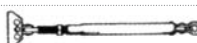
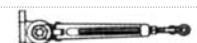

SPECIFY HANDLING:

"LH" OR "RH" for all
Fusible Link
Hold-Open Forearms.

WARRANTY:

Please refer to inside of Catalog front cover page.

CA6500 and CA6800 SERIES PARTS and ACCESSORIES

| Description | | Size | 2 & 3 | 4 & 5 |
|---|---|--------|------------|------------|
| Main Arm |  | Part # | CA620 | CA620 |
| Regular Forearm |  | Part # | CA521 | CA521 |
| Hold-Open Forearm |  | Part # | CA522 | CA522 |
| Fusible Link Hold-Open Forearm (Handed) |  | Part # | CA523 | CA523 |
| Top Jamb Forearm Extender |  | Part # | CA514 | CA514 |
| Parallel Bracket Regular Arm |  | Part # | CA525 | CA525 |
| Parallel Bracket for Hold-Open Arm |  | Part # | CA526 | CA526 |
| Flat Drop Plate (Door) |  | Part # | CA537 | CA547 |
| Flat Drop Plate (Header) |  | Part # | CA-TJB-53 | CA-TJB-54 |
| Thru Bolt and Grommet Nut (Set of 4 each) |  | Part # | CA-TBGN-50 | CA-TBGN-50 |
| Sex Nut and Bolt Set (1/4-20 x 1.75") (Set of 4 each) |  | Part # | CA-SNB-175 | CA-SNB-175 |



1481 North Main Street Orange, CA 92867-3403 U.S.A.

TEL: 714/633-5100 • Toll Free: 800/560-0012 • FAX: 714/633-5102



Adjustable Spring Tension (ADA) Hydraulic Door Closers



CA8000 Series

FEATURES

- Complies with ANSI A156.4 Grade 1.
- Barrier Free Operation to comply with Federal Accessibility Standards (ADA) and ANSI A117.1 (4,13,11).
- Underwriters' Laboratories Inc. Listed. Listed for UL10C for positive pressure and certified to conform to UBC 7.2 (1997) BS476 for Fire Safety.
- ADA Handicap multi-sized closers with adjustable spring tension for a range of sizes after installation :

DOOR CLOSER FUNCTIONS

CA8001...8 1/2 lb. Opening Force to Size 5.
Adjustable spring power with fully adjustable Back-Check controlled by a separate regulating valve, adjustable after installation.

CA8002...5 lb. Opening Force to Size 4.
Adjustable spring power with Delayed Closing action controlled by a separate regulating valve, adjustable after installation.

CA8003...5 lb. Opening Force to Size 4.
Adjustable spring power only.

CA8004...8-1/2 lb. Opening Force to Size 5.
Adjustable spring power only.



- **Dual Speed Control Valves :**
Closing and Latching speeds controlled by separate regulating valves, fully adjustable after installation.
- Universal application. Non-handed for Standard, Top Jamb, or Parallel Arm installation.
- Rack and pinion control mechanism contained in a high tensile precision die cast aluminum housing.
- Stable hydraulic door check fluid for any climatic operation and provides constant lubrication.
- Furnished with regular arm. Hold-open and fusible link hold-open arms optional. Hold-open arms are adjustable from 100° to 180° of door opening.
- Series CA8000 has available a high impact molded PVC Dress Cover permitting installation on most modern glass and aluminum door without adaptors.
- Attractive Baked Enamel finishes :
AL - Aluminum
DU - Storefront Bronze

ADA Opening Force Requirements

Caution: Any manual door closer, installed and adjusted based on ADA or other reduced opening force requirements may not provide sufficient power to reliably close and latch



CLOSER OVERVIEW (CA8000 Series)

| | |
|------------------------------------|----------|
| A. Length of Closer | 9-3/4" |
| B. Horizontal Mounting Holes | 9-1/16" |
| C. Vertical Mounting Holes | 3/4" |
| D. Overall Height | 4-21/32" |
| E. Top of Door to Bottom of Closer | 2-1/16" |
| F. Height of Closer | 1-3/4" |
| G. Projection from Door | 2-29/32" |

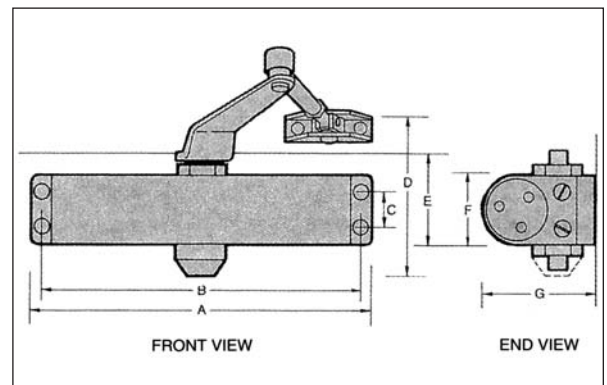

TYPICAL SURFACE MOUNTED DOOR CLOSER INSTALLATIONS (shown with Regular Forearms)

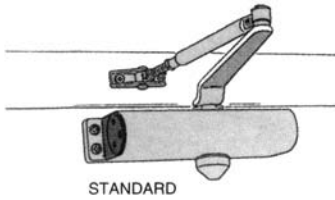

STANDARD

Standard Installation

Door closer mounted on the Door, on the **PULL** side.

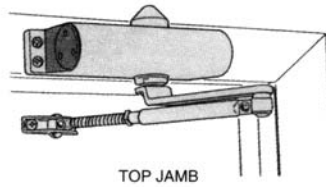

TOP JAMB

Top Jamb Installation

Door closer mounted on the Header, on the **PUSH** side.

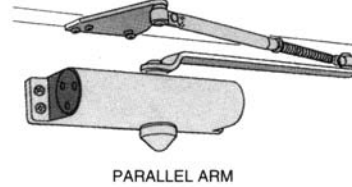

PARALLEL ARM

Parallel Arm Installation

Door closer mounted on the Door, on the **PUSH** side.

SPECIFY DOOR CLOSER MODEL WHEN ORDERING

| | Back-Check | Delayed Closing | Basic | Function |
|---------------------------|----------------|-----------------|----------------|---|
| Door Closers Model Number | 8001 8001-P | 8002 8002-P | 8003 8003-P | 8004 8004-P |
| | | | | Regular Forearm Application Parallel Arm Application |

NOTE:

Doors of unusual height or weight, or doors subject to severe wind or draft conditions, or abusive usage, may require additional turns of the hex spring adjustment nut than is indicated on the installation instructions.

SPECIFY:

Closer Model or Part Number.

SPECIFY FINISH:

AL - Aluminum
DU - Storefront Bronze

SPECIFY HANDLING:

"LH" OR "RH" for all Fusible Link Hold-Open Forearms.

WARRANTY:

Please refer to the inside of the Catalog front cover page.

CA8000 SERIES PARTS and ACCESSORIES

| Description | | Part Number |
|---|--|--------------|
| Main Arm | | # CA520 |
| Regular Forearm | | # CA521 |
| Hold-Open Forearm | | # CA522 |
| Fusible Link Hold-Open Forearm (Handed LH or RH) | | # CA523 |
| Top Jamb Forearm Extender | | # CA514 |
| Parallel Bracket for Regular Forearm | | # CA525 |
| Parallel Bracket for Hold-Open Forearm | | # CA526 |
| Flat Drop Plate (for Door Application) | | # CA547 |
| Top Jamb Plate (for Header Application) | | # CA-TJB-54 |
| PVC Dress Cover | | # CA-DC-8000 |
| Thru Bolt and Grommet Nut (Set of 4 each) | | # CA-TBGN-50 |
| Sex Nut and Bolt Set (1/4-20 x 1.75") (Set of 4 each) | | # CA-SNB-175 |



1481 North Main Street Orange, CA 92867-3403 U.S.A.
TEL: 714/633-5100 • Toll Free: 800/560-0012 • FAX: 714/633-5102



Standard/Adjustable Back-Check Hydraulic Door Closers

CA8850/CA8880 Series



FEATURES

- Complies with ANSI A156.4 Grade 1.
- Underwriters' Laboratories Inc. Listed. Listed for UL10C for positive pressure and certified to conform to UBC 7.2 (1997) BS476 for Fire Safety.
- **Range of Sizes :**
Standard: CA8851, CA8852, CA8853, CA8854 and CA8855
Back-Check: CA8883, CA8884 and CA8885
- **Dual Speed Control Valves :**
 Closing and Latching speeds controlled by separate regulating valves, fully adjustable after installation.
- CA8800 Series has adjustable Back-Check function controlled by a separate regulating valve, fully adjustable after installation.
- Universal application. Non-handed for Standard, Top Jamb, or Parallel Arm installation.
- The CA8850 and CA8880 Series are "fixed" spring door closers with no spring power adjustment.
- Rack and pinion control mechanism contained in a high tensile precision die cast aluminum housing.
- Stable hydraulic door check fluid for any climatic operation and provides constant lubrication.
- Furnished with regular arm. Hold-open and fusible link hold-open arms optional. Hold-open arms are adjustable from 100° to 180° of door opening.
- CA8850/CA8880 door closers are contained in four body casting sizes. Spring size 1 is contained in a Size 1 body casting, spring size 2 is contained in a Size 2 body casting, spring size 3 is contained in a Size 3 body casting, and spring sizes 4 and 5 are contained in a Size 4 body casting.
- Attractive Baked Enamel finishes:
 AL - Aluminum
 DU - Storefront Bronze



CLOSER OVERVIEW (SERIES CA8850 and CA8880)

| | Size 1 | Size 2 | Size 3 | Size 4&5 |
|------------------------------------|----------|---------|---------|----------|
| A. Length of Closer | 7-1/16" | 8-1/16" | 8-7/8" | 9-13/16" |
| B. Horizontal Mounting Holes | 6-3/8" | 7-3/8" | 8-3/16" | 9-1/16" |
| C. Vertical Mounting Holes | 3/4" | 3/4" | 3/4" | 3/4" |
| D. Overall Height | 4-1/16" | 4-3/4" | 4-3/4" | 4-3/4" |
| E. Top of Door to Bottom of Closer | 1-15/16" | 2-1/4" | 2-1/4" | 2-1/4" |
| F. Height of Closer | 1-5/8" | 1-3/4" | 1-3/4" | 1-3/4" |
| G. Projection from Door | 2-9/16" | 3" | 3" | 3" |

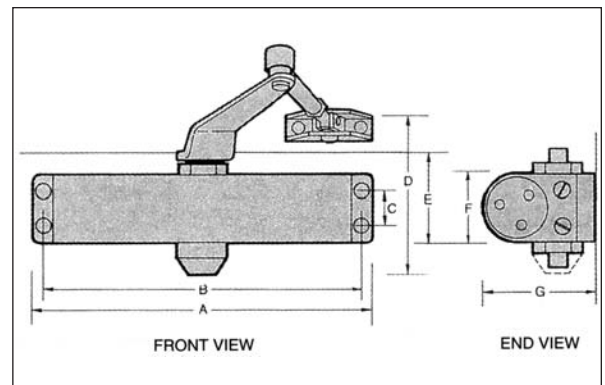

TYPICAL SURFACE MOUNTED DOOR CLOSER INSTALLATIONS (shown with Regular Forearms)

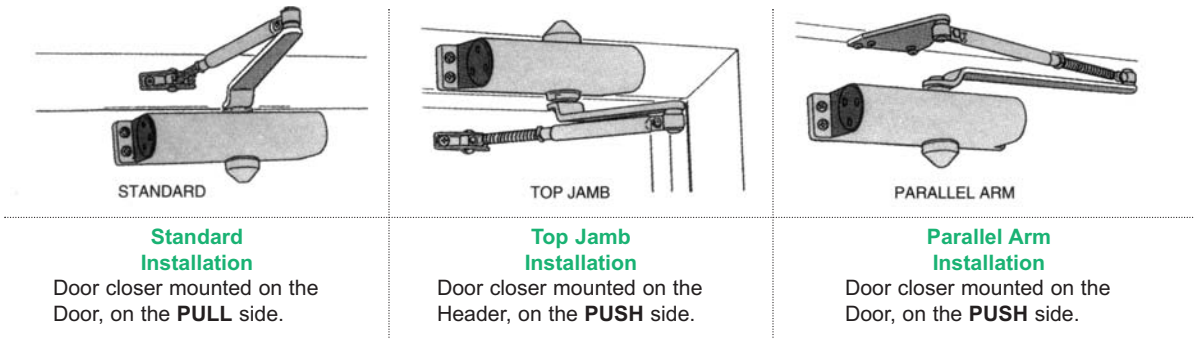

SPECIFY DOOR CLOSER MODEL WHEN ORDERING

| INTERIOR Door size | EXTERIOR DOOR SIZE | | MODEL NUMBER | | Function |
|-----------------------|--------------------|----------|--------------|------------|-----------------------------|
| | Swing Out | Swing In | Standard | Back-Check | |
| 32" | 28" | 24" | #8851 | n/a | Regular Forearm Application |
| 28" | 24" | - | #8851-P | n/a | Parallel Arm Application |
| 36" | 32" | 28" | #8852 | n/a | Regular Forearm Application |
| 32" | 28" | 24" | #8852-P | n/a | Parallel Arm Application |
| 42" | 36" | 32" | #8853 | #8883 | Regular Forearm Application |
| 36" | 32" | 28" | #8853-P | #8883-P | Parallel Arm Application |
| 48" | 42" | 36" | #8854 | #8884 | Regular Forearm Application |
| 42" | 36" | 32" | #8854-P | #8884-P | Parallel Arm Application |
| 54" | 48" | 42" | #8855 | #8885 | Regular Forearm Application |
| 48" | 42" | 36" | #8855-P | #8885-P | Parallel Arm Application |

NOTE:

Doors of unusual height or weight, or doors subject to severe wind or draft conditions, or abusive usage, may require the next stronger spring tension model closer.

SPECIFY:

Closer Model or Part Number.

SPECIFY FINISH:

AL - Aluminum
DU - Storefront Bronze











SPECIFY HANDLING:

"LH" OR "RH" for all Fusible Link Hold-Open Forearms.

WARRANTY:

Please refer to the inside of the Catalog front cover page.

CA8800 SERIES PARTS and ACCESSORIES

| Description | Size | 1 | 2 | 3 | 4 & 5 |
|---|--|-----------------------------------|-------|-----------|-----------|
| Main Arm |  Part # | CA510 | CA520 | CA520 | CA520 |
| Regular Forearm |  Part # | CA511 | CA521 | CA521 | CA521 |
| Hold-Open Forearm |  Part # | n / a | CA522 | CA522 | CA522 |
| Fusible Link Hold-Open Forearm (Handed) |  Part # | n / a | CA523 | CA523 | CA523 |
| Top Jamb Forearm Extender |  Part # | CA514 | CA514 | CA514 | CA514 |
| Parallel Bracket Regular Arm |  Part # | CA515 | CA525 | CA525 | CA525 |
| Parallel Bracket for Hold-Open Arm |  Part # | n / a | CA526 | CA526 | CA526 |
| Flat Drop Plate (Door) |  Part # | n / a | CA527 | CA537 | CA547 |
| Flat Drop Plate (Header) |  Part # | n / a | n / a | CA-TJB-53 | CA-TJB-54 |
| Thru Bolt and Grommet Nut (Set of 4 each) |  Part # | (All Door Closers P/N CA-TBGN-50) | | | |



1481 North Main Street Orange, CA 92867-3403 U.S.A.
TEL: 714/633-5100 • Toll Free: 800/560-0012 • FAX: 714/633-5102



Adjustable Spring Tension (ADA) Hydraulic Door Closers



CA9900 Series

FEATURES

- Complies with ANSI A156.4 Grade 1.
- Barrier Free Operation to comply with Federal Accessibility Standards (ADA) and ANSI A117.1 (4,13,11).
- Underwriters' Laboratories Inc. Listed. Listed for UL10C for positive pressure and certified to conform to UBC 7.2 (1997) BS476 for Fire Safety.
- ADA Handicap multi-sized closers with adjustable spring tension for a range of sizes after installation:

DOOR CLOSER FUNCTIONS

CA9901... 8 1/2 lb. Opening Force to Size 5.
Adjustable spring power with fully adjustable Back-Check controlled by a separate regulating valve, adjustable after installation.

CA9903... 5 lb. Opening Force to Size 4.
Adjustable spring power with both adjustable Back-Check and adjustable Delayed Closing Action controlled by separate, regulating valves, adjustable after installation.

ADA Opening Force Requirements

Caution: Any manual door closer, installed and adjusted based on ADA or other reduced opening force requirements may not provide sufficient power to reliably close and latch the door.



- **Dual Speed Control Valves :**
Closing and Latching speeds controlled by separate regulating valves, adjustable after installation.
- Universal application. Non-handed for Standard, Top Jamb, or Parallel Arm installation.
- Rack and pinion control mechanism contained in a high tensile precision die cast aluminum housing.
- Stable hydraulic door check fluid for any climatic operation and provides constant lubrication.
- Furnished with regular arm. Hold-open and fusible link hold-open arms optional. Hold-open arms are adjustable from 100° to 180° of door opening.
- Series CA9900 furnished with high impact molded PVC Dress Cover (door closer body casting can be used without the Dress Cover permitting installation on most modern glass and aluminum door without adaptors). Parallel Bracket included.
- Attractive Baked Enamel finishes :
AL - Aluminum
DU - Storefront Bronze
- Optional US3 Bright Brass and US26 Bright Chrome are available.



CLOSER OVERVIEW (Models CA9901 & CA9903)

| | |
|------------------------------------|----------|
| A. Length of Closer | 12-1/8" |
| B. Horizontal Mounting Holes | 11-3/32" |
| C. Vertical Mounting Holes | 3/4" |
| D. Overall Height | 4-9/16" |
| E. Top of Door to Bottom of Closer | 3-5/16" |
| F. Height of Closer | 2-13/16" |
| G. Projection from Door | 2-9/16" |

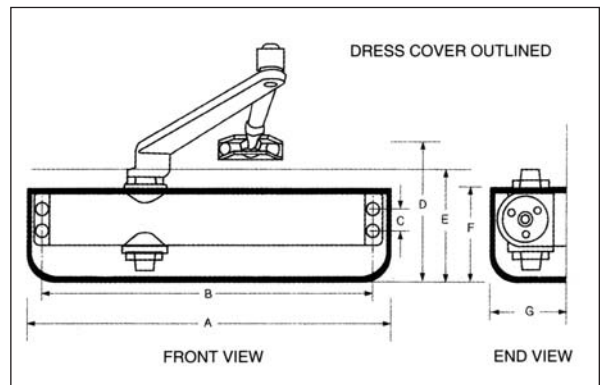

TYPICAL SURFACE MOUNTED DOOR CLOSER INSTALLATIONS (shown with Regular Forearms)

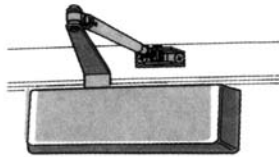

STANDARD

Standard Installation

Door closer mounted on the Door, on the **PULL** side.

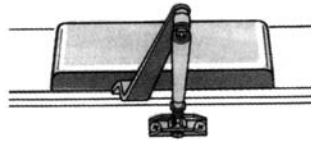

TOP JAMB

Top Jamb Installation

Door closer mounted on the Header, on the **PUSH** side.

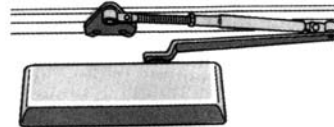

PARALLEL ARM

Parallel Arm Installation

Door closer mounted on the Door, on the **PUSH** side.

SPECIFY DOOR CLOSER MODEL WHEN ORDERING

| | Back-Check | Delayed Closing and/or Back-Check | Function |
|---------------------------|------------|-----------------------------------|---|
| Door Closers Model Number | 9901 | 9903 | Regular Forearm Application or Parallel Arm Application |

NOTE:

Doors of unusual height or weight, or doors subject to severe wind or draft conditions, or abusive usage, may require additional turns of the hex spring adjustment nut than is indicated on the installation instructions.

SPECIFY:

Closer Model or Part Number.

SPECIFY FINISH:

AL - Aluminum
DU - Storefront Bronze











SPECIFY HANDLING:

"LH" OR "RH" for all Fusible Link Hold-Open Forearms.

WARRANTY:

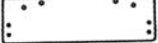
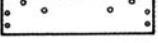
Please refer to the inside of the Catalog front cover page.

CA9900 SERIES PARTS and ACCESSORIES

| Description | | Part Number |
|---|--|---------------|
| Main Arm |  | # CA920 |
| Regular Forearm |  | # CA521 |
| Hold-Open Forearm |  | # CA522 |
| Fusible Link Hold-Open Forearm (Handed LH or RH) |  | # CA523 |
| Top Jamb Forearm Extender |  | # CA514 |
| Parallel Bracket for Regular Forearm |  | # CA525 |
| Parallel Bracket for Hold-Open Forearm |  | # CA526 |
| Flat Drop Plate (for Door Application) |  | # CA9907 |
| Top Jamb Plate (for Header Application) |  | # CA-TJB-9900 |
| PVC Dress Cover |  | # CA-DC-9900 |
| Thru Bolt and Grommet Nut (Set of 4 each) |  | # CA-TBGN-50 |
| Sex Nut and Bolt Set (1/4-20 x 1.75") (Set of 4 each) |  | # CA-SNB-175 |



1481 North Main Street Orange, CA 92867-3403 U.S.A.

TEL: 714/633-5100 • Toll Free: 800/560-0012 • FAX: 714/633-5102



Glass and Aluminum Storefront Door Hardware Product

QUALITY
VALUE
SERVICE

CA/Hardware Series

INTRODUCTION

The manufacturers of **Calibre®** hardware have been successfully producing storefront hardware since 1982. The manufacturers are ISO certified and have a proven record for quality and dependability throughout both the United States and Europe.

Calibre® storefront hardware is not unique, or exotic. Our storefront hardware is the "meat and potatoes" that has become the mainstay for the storefront industry. The people of **Calibre®** offer you 38-years of experience that will provide you the best possible quality and help you to better control your material costs.

Most of these hardware items have been widely used by the glass and aluminum storefront OEM manufacturers and glazing contractors throughout the U.S. for many years. **Calibre®** brings a new element to you, the customer, by assuring you Quality, Value & Service that you can trust and depend on.

The next time you are placing an order for your storefront hardware (or for your Door Closers), why not consider giving **Calibre®** an opportunity to prove to you that we can do it not only better, but perhaps even save you some money, and aggravation. Please give us a call.

GENERAL FEATURES

- Precision die cast A380 aluminum alloy is used for aluminum hardware castings.
- Quality, homogenized steel used for all steel stampings for all locks, and security hardware product.
- All machining is performed with state of the art equipment for precision and uniformity throughout all phases of production.
- All painted surfaces are either baked enamel, or powder coating (depending on the product) for durability and long lasting finishes.
- Quality Control and Assurance is maintained throughout all phases of manufacturing, packaging, and periodically checked prior to shipments leaving our distribution center.
- Attractive Baked Enamel and Powder Coated finishes:
 - AL - Aluminum
 - BK - Black
 - DU - Storefront Bronze

<< MS STOREFRONT LOCKS, FACEPLATES & CYLINDERS >>

- LS-1000** - Long Throw Deadlock (Throw 1-3/8")
- LS-2000** - Hook Bolt Deadlock (Throw 1-3/16")
- LS-3000** - Short Throw Deadlock (Throw 1-3/16")

- Cylinder backsets available: 1-1/2", 1-1/8", and 31/32". (LS-3000: 1-1/8" Backset Only).
- Bolts made of 5-ply laminated steel with a hardened roller pin inserted in a case hardened center ply for maximum security.
- Locks use standard 1-5/32" Mortise Key or Thumbturn Cylinders with AR MS-Type cam.

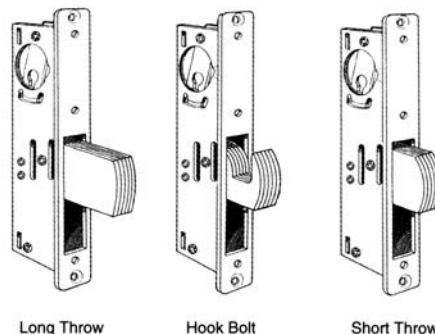

DEADLATCH LOCKS

LS-4000 - Deadlatch Lock

- Cylinder backsets available: 1-1/8", and 31/32".
- Latchbolt has 1/2" throw, and is chrome plated with a Delrin insert for quiet latching.
- Lock is field reversible for opposite hand.
- Locks use standard 1-5/32" Mortise Key or Thumbturn Cylinders with AR MS-Type cam.
- Deadlatch Lock provides key controlled dogging.
- Standard ST-5000 Strike included (US 26D finish).

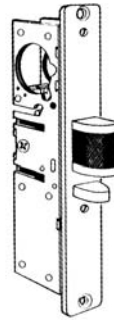





Deadlatch Lock
(LH Shown)

Specify: Cylinder Backset and Handing (if required)

LOCK FACEPLATES

- Faceplates measure 1" x 6-7/8", are ordered separately, and include faceplate screws.
 - For Use With the following Locks:
- | | | | | | | |
|---------|----------------------|----------------|----------------|----------------|----------------|----------------|
| LS-1000 | Long Throw | FA-1001 | FA-1002 | FA-1003 | FA-1004 | FA-1005 |
| LS-2000 | Hook Bolt..... | FA-2001 | FA-2002 | FA-2003 | FA-2004 | FA-2005 |
| LS-3000 | Short Throw | | | | | |
| LS-4000 | Deadlatch Lock | FA-4001 | FA-4002 | FA-4003 | FA-4004 | FA-4005 |

| | | | | |
|---|---|---|---|---|
|  |  |  |  |  |
| Flat | Radius | Radius Weatherstripped | Left Hand Beveled | Right Hand Beveled |
| FA-1001 | FA-1002 | FA-1003 | FA-1004 | FA-1005 |
| FA-2001 | FA-2002 | FA-2003 | FA-2004 | FA-2005 |
| FA-4001 | FA-4002 | FA-4003 | FA-4004 | FA-4005 |

- Finishes available:
 - AL - Anodized Satin Aluminum
 - BK - Anodized Black
 - DU - Anodized Storefront Bronze

Specify: Part Number and Finish

CYLINDERS

- CL-1000** - Mortise Key Cylinder
- DM-1000** - Mortise Dummy Cylinder
- TH-1000** - Mortise Thumbturn Cylinder
- RM-1000** - Rim Cylinder

- Zinc Die Cast cylinders, with core faces, keys, and thumbturn T-Turn US 26D. Cylinder faces (scalps) anodized aluminum.
- Mortise Key Cylinder and Mortise Thumbturn with AR MS-Type cam.
- Mortise Key Cylinder with Schlage "C" Keyway. Specify cylinder pairs as KA-2 or KA (keyed alike in maximum of 50 pairs each).
- Standard 3/16" cylinder trim ring furnished.
- Finishes available:
 - AL - Anodized Satin Aluminum
 - BK - Anodized Black
 - DU - Anodized Storefront Bronze

Mortise Key Cylinder



Mortise Dummy Cylinder



Mortise Thumbturn Cylinder



Rim Cylinder

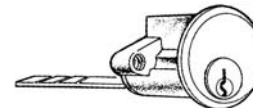

Specify: Finish and KA-2 or KA (quantity)

Glass and Aluminum Storefront Door Hardware Product

QUALITY
VALUE
SERVICE

CA/Hardware Series

<< SECURITY HARDWARE >>

CYLINDER GUARD SETS

- GU-1000** - Cylinder Guard Set (w/ Retaining Clip)
- GU-2000** - Cylinder Guard Set (Cylinder Secured Only)

- Security Ring is made from Hardened Steel.
- For use with Standard Face 5 pin Mortise Cylinder that fits into a free-spinning beveled collar.
- GU-1000 furnished with retaining clip and 2 spacers. High security with Security Ring fastened from inside of the door stile. GU-2000 held in place only by the mortise cylinder secured into the lock.
- Finishes (Powder Coated) available:
 - AL - Aluminum
 - BK - Black
 - DU - Storefront Bronze

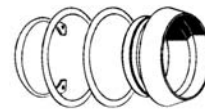

GU-1000

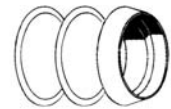

GU-2000

Specify: Part Number and Finish

HEADER BOLT SETS

- BH-8500** - **Header Bolt Set**
For use in doors with the Centerline of the cylinder to the top of the door between 30-1/2" to 50".
- BH-8600** - **Header Bolt Set**
For use in doors with the Centerline of the cylinder to the top of the door between 55-5/8" to 77-1/2".
- BH-8700** - **Header Bolt Set**
For use in doors with the Centerline of the cylinder to the top of the door between 67" to 89".
- BH-8800** - **Special Header Bolt Set** (Use in an Astragal Stile)
Standard for 84" Doors with the Cylinder height not less than 33".

- Inactive leaf security when used with the **LS-1000** Long Throw Deadlock in the active leaf.
- BH-8500/8600/8700 have Expanding Bolt with 5/8" upward throw.
- Units come complete with Rod Guide and Header Strike.
- Simple adjustments can be made after installation.



BH-8500/8600/8700



BH-8800

Specify: Part Number

THRESHOLD BOLT KITS

BT-6000 - Standard Threshold Bolt Kit

Standard for doors with cylinder heights between 34" to 37".

BT-5000 - Long Threshold Bolt Kit

Optional for doors with cylinder heights up to 53-1/2".
The threaded rod portion can be cut for cylinder heights less than 53-1/2".

- Complete unit for attachment to basic Deadlock to provide maximum two-point lock security (at the lock jamb, and in the threshold).
- Unit provides 11/16" bolt throw when activated by the Deadlock.
- Furnished with a hardened steel hexagon Bottom Rod Bolt.
- Includes Top Rod Arm Adaptor, Bottom Rod Guide and Spring Roll Pin for installation into the Deadlock.



Specify: Part Number

<< DOOR HANDLES >>

LEVER HANDLE SETS

LH-4000 - Straight Lever Handle Set (LH or RH)

LH-4500 - Eurostyle Return End Lever Handle (LH or RH)

- For use with LS-4000 Deadlatch Lock. Includes field reversible Cam Plug.
- Lever portion baked enamel finish to resist scratching and chipping.
- Eurostyle Return End with 1/2" clearance for UBC anti-snap code requirements and Fire Safety.
- Finishes (Escutcheon) available:
 - AL - Painted Satin Aluminum
 - BK - Painted Black
 - DU - Painted Storefront Bronze

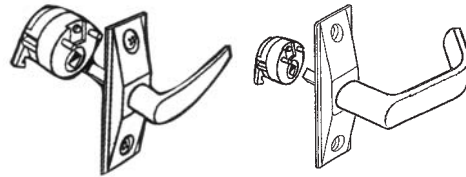

LH-4000

LH-4500

Specify: Part Number, Finish and Handling (if required)

PADDLE HANDLE SETS

PA-1000 - Paddle Handle Set (Push to the LEFT)

PA-2000 - Paddle Handle Set (Push to the RIGHT)

- For use with LS-4000 Deadlatch Lock. Includes field reversible Cam Plug.
- Complete unit is field reversible for either PUSH or PULL function, and for opposite handing with both PUSH and PULL Plates included.
- Extruded, anodized Aluminum paddle plate for long lasting wear and use.
- Finishes (Escutcheon Housing) available:
 - AL - Painted Satin Aluminum
 - DU - Painted Storefront Bronze

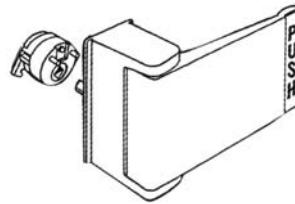

Specify: Part Number, Finish and Handling (if required)

Glass and Aluminum Storefront Door Hardware Product

**QUALITY
VALUE
SERVICE**

CA/Hardware Series

<< STOREFRONT PIVOT SETS >>

OFFSET PIVOT SETS

(3/4" Offset for use with Aluminum Doors and Frames)

PV-1000 - For use on Flush Doors

PV-1500 - For use on 1/8" Recessed Doors

PV-3000 - For use on Flush Doors

PV-3500 - For use on 1/8" Recessed Doors

PV-4000 - For use on Flush Doors

- A380 aluminum alloy precision die cast pivot portions.
- Oilite bronze bushing in top frame pivot portion.
- Case hardened, spring loaded pin in Top Door pivot portion.
- Full race ball bearing in Bottom Door Pivot portion.
- Steel reinforcement plates for door portions provided with PV-5000 and PV-7000.
- Bottom Door pivot portion with 3/16" vertical height adjustment in the bearing with PV-5000 and PV-7000.

PV-5000 - For use on 1/8" Recessed Doors (YKK Type)
(includes Door Reinforcement Plates)

PV-6000 - For use on 7/64" Recessed Doors

PV-7000 - For use on 1/8" Recessed Doors (Kawneer 50-300 Type) (includes Door Reinforcement Plates)

- Case hardened pivot stud in Floor/Jamb pivot portion
- Floor/Jamb portion with 1/8" vertical height adjustment.
- Finishes available:
 - AL - Satin Aluminum
 - SL - Sanded and Lacquer (PV-4000 Only)
 - BK - Black
 - DU - Storefront Bronze

Specify: Part Number and Finish

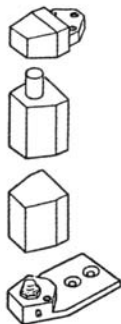

PV-1000
(Flush Door)
J-27 Type

Non-Handed

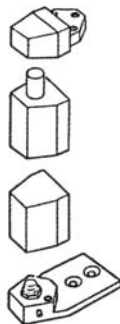

PV-1500
(1/8" Recess)
J-28 Type

Non-Handed

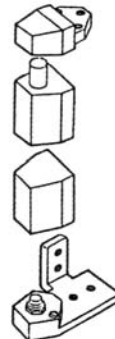

PV-3001
(LH Flush Door)
J-30 Type

PV-3002
(RH Flush Door)
J-30 Type
(RH Shown)

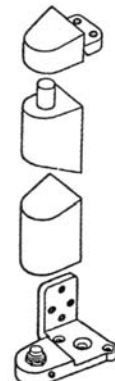

PV-3501
(LH 1/8" Recess)
J-31 Type

PV-3502
(RH 1/8" Recess)
J-31 Type
(RH Shown)

<< STOREFRONT PIVOT SETS - CONTINUED >>

OFFSET PIVOT SETS

(3/4" Offset for use with Aluminum Doors and Frames)

Specify: Part Number and Finish

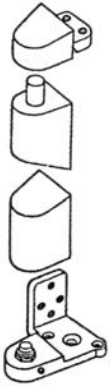

PV-4001
(LH Flush Door)
J-34 Type

PV-4002
(RH Flush Door)
J-34 Type
(RH Shown)

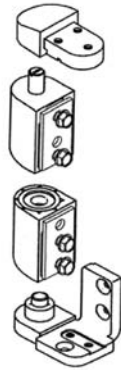

PV-5001
(LH 1/8" Recess)
YKK Type

PV-5002
(RH 1/8" Recess)
YKK Type
(RH Shown)

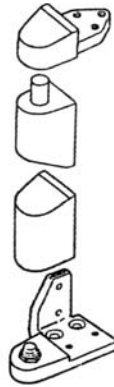

PV-6001
(LH 7/64" Recess)
J-40 Type

PV-6002
(RH 7/64" Recess)
J-40 Type
(RH Shown)

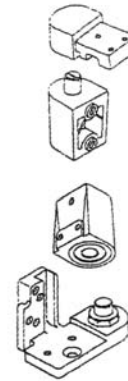

PV-7001
(LH 1/8" Recess)
Kawneer Type

PV-7002
(RH 1/8" Recess)
Kawneer Type
(LH Shown)

REPLACEMENT OFFSET PIVOT SET

(3/4" Offset for use with Aluminum Doors and Frames)

PV-6890 - Non-handed Replacement Pivot Set

- Precision die cast for excellent tensile and shear strength.
- Radius in critical corners for additional fatigue strength.
- Full Race Ball Bearing in Bottom Bearing Housing.
- Non-handed for use in 1-3/4" Aluminum Storefront Doors.
- For use in doors weighing not more than 130 pounds.
- Standard Baked Enamel Finishes available:
AL - Painted Satin Aluminum
DU - Painted Storefront Bronze

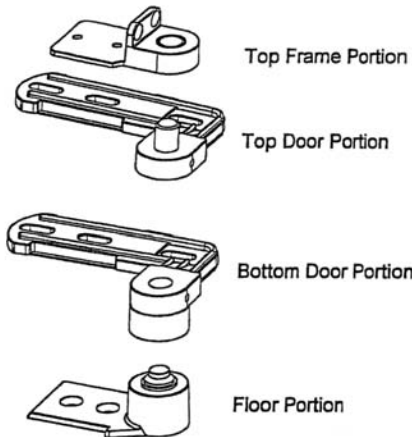

Specify: Finish

Glass and Aluminum Storefront Door Hardware Product

**QUALITY
VALUE
SERVICE**

CA/Hardware Series

<< STOREFRONT PIVOT SETS >>

INTERMEDIATE PIVOT SET

(3/4" Offset for use with Aluminum Doors and Frames)

IN-1401S - LEFT Hand (HRSO)
IN-1402S - RIGHT Hand (HLSO)

- A380 Aluminum Alloy precision die cast.
- Combination Slotted Frame Portion (Handed) and Surface Applied Door Portion.
- For either Flush Door or 1/8" Recessed Door application.
- Standard Baked Enamel Finishes available:
 - AL - Painted Satin Aluminum
 - BK - Painted Black

DU - Painted Storefront Bronze

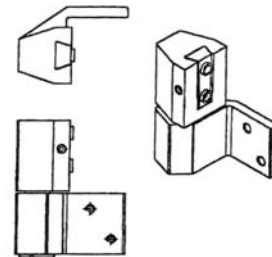

**RIGHT Hand Shown
(LEFT Hand Opposite)**

Specify: Model Number and Finish

INTERMEDIATE PIVOT SETS

(3/4" Offset for use with Aluminum Doors and Frames)

IN-8001 - Mortise Type (LEFT Hand)
IN-8002 - Mortise Type (RIGHT Hand)

IN-9001 - Slotted Type (LEFT Hand)
IN-9002 - Slotted Type (RIGHT Hand)

- Full race ball bearing backed by an oilite bronze bushing in the Door Portion.
- Case hardened steel pin in Jamb Portion, fully retractable for ease of installation and easy vertical adjustment.
- IN-8000 - Precision A380 aluminum die cast.
- IN-9000 - Precision aluminum extrusion, or die cast.
- Standard Baked Enamel Finishes available:
 - AL - Painted Satin Aluminum
 - BK - Painted Black Paint
 - DU - Painted Storefront Bronze

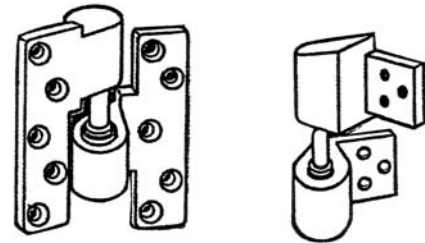

IN-8000

IN-9000

Specify: Model Number and Finish

CENTER HUNG PIVOTS (Walking Beam Pivots)

For use with Aluminum Doors and Frames

500-PF - Frame Portion (Mounting Holes Drilled & Tapped)
500-PF-1 - Frame Portion (Mounting Holes Drilled & Countersunk)
500-PD - Door Portion (Mates to the Frame Portion)
500-PC - Dress Plate (For use with the 500-PF-1 only)

- Finishes available (Dress Plate Only) :
 - AL - Satin Aluminum
 - DU - Storefront Bronze

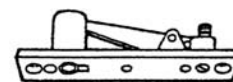

**500-PF
500-PF-1**

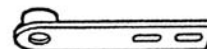

500-PD

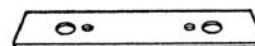

500-PC

Specify: Part Number and Finish

<< FLUSHBOLTS, PARTS and ACCESSORIES >>

FLUSHBOLTS

- FL-1002** -Standard Flushbolt, 1/8" Offset for use on a non-weatherstripped door stile. Standard 5/8" throw when activated.
- FL-1004** -Standard Flushbolt, 1/4" Offset for use on a weatherstripped door stile. Standard 5/8" throw when activated.
- FL-1006** -Standard Flushbolt, 3/16" Offset for special application as required. Standard 5/8" throw when activated.
- FL-2002** -Optional Flushbolt, 1/8" Offset for use on a non-weatherstripped door stile. Optional 7/8" throw when activated.
- FL-2004** -Optional Flushbolt, 1/4" Offset for use on a weatherstripped door stile. Optional 7/8" throw when activated.
- FL-3001** -Special Kawneer Type Flushbolt, 1/8" Offset for use on a non-weatherstripped door stile. No Flushbolt Guide.

- Radius Flushbolt Face measuring 15/16" x 4-1/4".
- Positive "U" joint actuator for secure locking.
- Flushbolt Rod length for 12" Centerline of face Installation.
- Square Nylon Rod Tip with beveled corners fits in 1/2" round hole.
- Includes FG-1000 Standard Flushbolt Guide and screws.
- Finishes available:
 - AL - Baked Satin Aluminum Paint
 - BK - Baked Black Paint
 - DU - Baked Storefront Bronze Paint

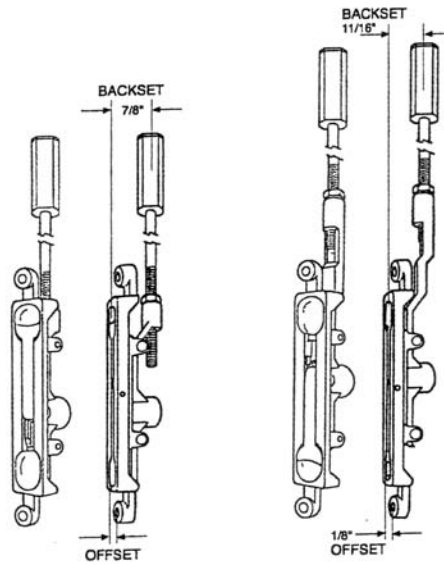

**FL-1000/2000
TYPE**

**FL-3001
TYPE**

Specify: Part Number and Finish

FLUSHBOLT GUIDES

- FG-1000** - Standard Flushbolt Rod Guide (White)
- FG-2000** - Extended Hole Flushbolt Rod Guide (Brown)

- For use with FL-1000 and FL-2000 Flushbolts.
- Includes installation screws.



FG-1000

FG-2000

Specify: Finish for Screws

FLUSHBOLT EXTENSION RODS AND SPECIAL RODS

- RE-1000** - Threaded rod extender measuring 1/4-20 x 12". Includes Rod Coupler.
- RF-2000-R** - Special Flushbolt Rod with 1/2" solid round steel rod tip, measuring 1/4-20 x 12".



RE-1000



Glass and Aluminum Storefront Door Hardware Product

CA/Hardware Series

QUALITY
VALUE
SERVICE

DOOR FORCE MEASURING GAUGE

DFG-1000 - Door Force Gauge

As set forth in Appendix A to Part 1191-1: Americans with Disabilities Act 1990 (ADA) Accessibility Guidelines for Buildings and Facilities, and further referenced in text ANSI A117.1 from the American National Standards Institute, requires that both interior and exterior doors of a building be handicapped accessible.

4.13.11 Door Opening Force. The maximum force for pushing or pulling open a door shall be as follows:

- (1) Fire doors shall have the minimum opening force allowable by the appropriate administrative authority.
- (2) Other doors
 - (a). exterior hinged doors: (Reserved requirement)
 - (b). interior hinged doors: 5 lbs. (22.2N)

These forces do not apply to the force required to retract latch bolts or to disengage other devices that may hold the door in a closed position.

Some State and local municipalities may enforce guidelines that differ from the Federal guidelines. Furthermore, Building Code inspectors may have a different enforcement agenda to that of Health Code inspectors, and the Fire Marshall's code requirements. Contacting your State, County, or City Building Code Enforcement will best determine which code requirement is most applicable to your specific circumstances.

- Measures Door Opening and Closing Forces 0-35 lbs.
- Easy to use and accurate to within 1/4 lb. when used properly and in accordance with ANSI force measuring standards.



RETROFIT LOCK FILL COVER PLATE

LFP-1002 - For Use on a Radius Door Stile

LFP-1004 - For Use on a Beveled Door Stile

- Can be used to fill the faceplate cut-out in the lock stile when the MS Deadlock, or Deadlatch type lock requires removal for the installation of a Rim Panic Exit Device to meet certain Building Code Requirements.
- Installs using (2) 10-32 x 2" screws and Compression Springs, into the existing lock prep in the back of the door stile.
- Standard Anodized Finishes Available:
 - AL - Anodized Aluminum
 - DU - Anodized Storefront Bronze

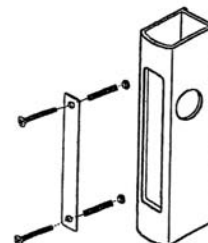

Specify: Model Number and Finish

STRIKE SETS

- ST-1000** - Strike Set, used for the new installation of a LS-4000 Type Deadlatch Lock in an Offset Door and Frame.
- ST-2000** - Strike Set, used when replacing a MS Type Lock with a LS-4000 Type Deadlatch Lock on an Offset Door and Frame.
- ST-4000** - Strike Sets, used for the new installation of a
- ST-4500** - LS-4000 Type Deadlatch Lock in a Center Hung Door and Frame.
- ST-5000** - Standard Flat Strike as furnished with the LS-4000 Deadlatch Lock.

- Non-handed Stainless Steel Strike for Left or Right Hand installation.
- Dustbox, Back-up Plate, and installation screws included.
- ST-4000 for use on a 4" Door Jamb, and the ST-4500 for use on a 4-1/2" Door Jamb.

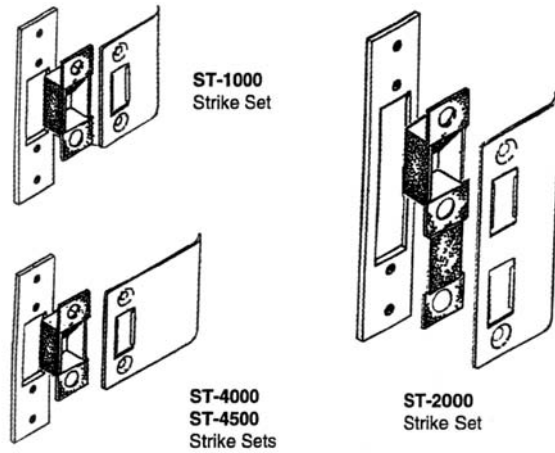

Specify: Part Number

UNIVERSAL PULL-HANDLE

- UH-1200** - Universal Multi-sized Offset Pull Handle
- Standard 12" CTC Offset Pull Handle with Press Fitting End Brackets.
- On site adjustment (cutting of stanchion) to match any existing installation centerline hole dimensions from 12" CTC to 4" CTC.
- Stanchion Bar is 6063 T5 extruded aluminum with a Class 1 anodized electrolytic finish.
- Press fitting End Brackets are a 380 aluminum die cast alloy with a high quality thermosetting polyester powder coated finish.
- Universal 1/4-20 fasteners are included for Thru-Bolt, Concealed, and Back-to-Back installations. Includes 2 each countersunk Trim Washers.
- Finishes available:
 - AL - Aluminum with Black End Brackets

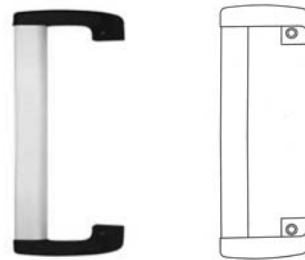

Specify: Part Number and Finish

STOREFRONT DOOR MODIFICATION KIT

GKL-B1-KIT - Narrow Stile Deadlock/Deadlatch Lock Fill Plates

The GKL-B1-Kit is used for closing the prepared openings of the Lock, Faceplate, and Cylinder holes in the door stile when the lock is removed for the installation of auxiliary hardware.

- GKL-B1-KIT includes (3) bridge supports and spacers for securing the blank faceplate into place.
- The bridge supports can be used to re-secure the lock into place should the tapped holes in the door stile strip out.
- Two cylinder hole caps provided which can be installed individually allowing space inside stile for CVR rod mechanism, or cylinder caps can be installed using double-ended 10-32 screw. Spanner Key (P/N GKL-SK1) ordered separately.
- Finishes available:
 - AL - Painted Satin Aluminum
 - DU - Painted Storefront Bronze

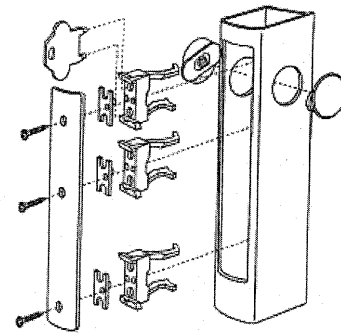

Specify: Part Number and Finish

Glass and Aluminum Storefront Door Hardware Product

QUALITY
VALUE
SERVICE

CA/Hardware Series

<<MISCELLANEOUS HARDWARE - CONTINUED>>

AUXILIARY PANIC EXIT HARDWARE

MODEL 7085P - Concealed Vertical Rod Paddle Device

MODEL 7095P - Rim Mounted Paddle Device

- Underwriters' Laboratories Inc. Listed - Panic Hardware.
- Conforms to ANSI A156.3-2001 Types 1 and 6, Emergency Exit.
- Model 7085P for Concealed Vertical Rod (1085) Storefront Door Application. Model 7095P for Storefront Door, Hollow Metal Door and Wood Door application.
- Requires 1-3/4" mounting surface for typical use on Narrow, Medium, and Wide Stile Aluminum Doors. Installs using 1/4-20 concealed Shoulder Bolts.
- Handed - For use on either LHRB (RH) or RHRB (LH) doors.
- Dogging by slotted Dogging Screw in bottom of each Pad Assembly.
- Model 7095P utilizes a 15/16" forged steel Latch Bolt with 1/2" throw to engage frame mounted strike.
- Finishes Available:
 - AL - Aluminum Sanded and Lacquer Finish
 - DU - Painted Storefront Bronze

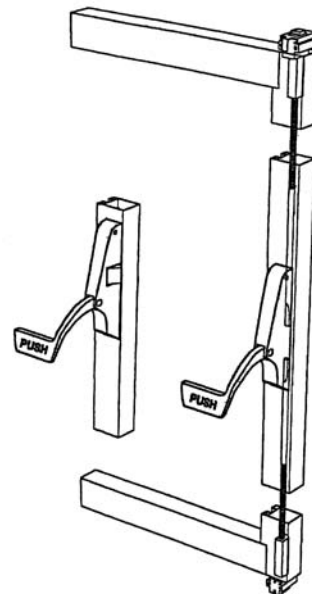

Specify: Model, Finish and Handling

<< MISCELLANEOUS HARDWARE >>

LOCK INDICATOR SET

LO-1000 - Standard lock Indicator Set.

- Designed for use with the LS-1000, LS-2000 and LS-3000 type Deadlocks.
- "OPEN" in green and "LOCKED" in red letters on a white background.
- Includes the adhesive backed SI-2000 Header Sign "THESE DOORS TO REMAIN UNLOCKED WHENEVER THE BUILDING IS OCCUPIED".
- Includes all installation hardware (screws and pins).
- Finishes available:
 - AL - Painted Satin Aluminum
 - BK - Painted Black
 - DU - Painted Storefront Bronze



Specify: Part Number and Finish

<<MISCELLANEOUS HARDWARE - CONTINUED>>

KICK DOWN DOOR STOP

DH-40 - 4" Kick Down Door Holder

- Solid Cast Iron construction.
- Non-marring Rubber Shoe, with replacement Rubber shoes available.
- Finishes available:
 - AL - Painted Aluminum
 - DU - Painted Storefront Bronze

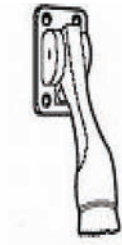

Specify: Part Number and Finish

PUSH DOWN DOOR HOLDER

DH-70 - European Plunger Type Door Holder

- Heavy Duty Zinc Die Cast construction.
- Convenient foot activated step-on to lock or release holder mechanism.
- Non-skid rubber pad to hold door firmly in the open position.
- Holder has 1-1/4" Throw to accommodate most bottom door clearances.
- Finishes Available:
 - AL - Painted Satin Aluminum
 - DU - Painted Storefront Bronze

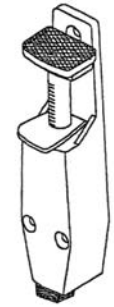

Specify: Part Number and Finish

WALL STOP/HOOK COMBINATION

WS703XP - Wall Door Stop & Holder with Hook

- Solid Cast Brass with a 3-5/8" projection; includes Hook & Plate for hold-open.
- Protects both the wall and door from collision damage.
- Furnished with 5/16-18 Lag Screws and Anchors.
- Finishes available:
 - US26D - Dull Chromium
 - US10B - Dark Oil Rubbed Bronze

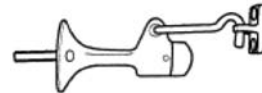

Specify: Part Number and Finish

FLOOR STOP/HOOK COMBINATION

FS704XP - Floor Stop & Holder with Pin-Hook

- Solid Cast Brass with a 3-5/8" projection; includes Hook & Plate for hold-open.
- Protects both the wall and door from collision damage.
- Furnished with 5/16-18 Lag Screws and Anchors
- Finishes available:
 - US26D - Dull Chromium
 - US10B - Dark Oil Rubbed Bronze



Specify: Part Number and Finish



Glass and Aluminum Storefront Hardware Hardware Product

QUALITY
VALUE
SERVICE

CA/Hardware Series

<< SIGNAGE >>

TRANSOM HEADER SIGNS

- SI-1000** - For use on a single door opening.
- SI-2000** - For use on a pair of doors.
- SI-3000** - For use on a single door opening.

- General purpose use on transoms and door headers.
- Attractive one piece, self-adhesive decals.
- Printed Black lettering on an aluminum background.

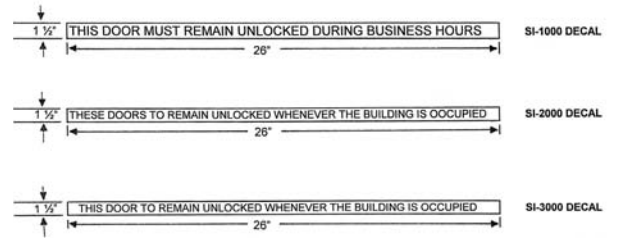

Specify: Part Number

DEADLATCH CAM PLUG

CP-1000 - Standard Cam Plug

- For use with the LH-4000 Lever Handle and the PA-1000/2000 Paddle Handle when installing into the LS-4000 Deadlatch Lock.
- Cam Plug is non-handed, field reversible.



Specify: Handing, if required

This Space was left intentionally Blank.

This Page was left intentionally Blank.



1481 North Main Street Orange, CA 92867-3403 U.S.A.
TEL: 714/633-5100 • Toll Free: 800/560-0012 • FAX: 714/633-5102

Glass and Aluminum Storefront Door Hardware Product

QUALITY
VALUE
SERVICE

CA/Hardware Series

<< PUSH BARS and PULL HANDLES >>

OFFSET & STRAIGHT PULL HANDLES

- PH-2000** - Offset Pull Handle
- PH-2002** - Offset Pull Handle Set
- PH-1000** - Straight Pull Handle
- PH-1002** - Straight Pull Handle Set

SINGLE BEND & DOUBLE BEND PUSH BARS

- PB-1000** - Single Bend Push Bar
- PB-2000** - Double Bend Push Bar

- 1" Diameter solid round aluminum extrusion, precision formed and machined.
- High performance architectural Class 1 anodized finishes for abusive use and UV protection.
- Product meets or exceeds AAMA 611-98 specifications.
- Offset Pull Handles with 3-1/4" offset, 2-1/4" projection, and 2-1/4" door clearance.
- Straight Pull Handles with 3" projection, and 2" door clearance.
- Push Bars with 2-1/4" projection.
- **Push Bars can be ordered with Pull Handles for a Push/Pull Set.** Specify Push/Pull combination use when ordering for correct mounting hardware package.
- Mounting hardware included. Specify Thru-Bolt or Concealed fasteners for individual Pull Handles. Push Bars are Concealed at the Lock Jamb and Thru-Bolt at the free ends. Push/Pull Set is Back-to-Back at the meet and Thru-Bolt at the free ends.
- Pull Handles CTC 9", 10" and 12". Push Bars are CTC 33-1/16" (for a 36" Door) and CTC 45-1/16" (for a 48" door)
- Polished Brass (US3) solid bent rod and Stainless Steel (US32 & US32D) solid bent rod finishes are available by special order.
- Finishes available:
 - AL - Anodized Aluminum
 - BK - Anodized Black
 - DU - Anodized Storefront Bronze



PH-2000



PH-2002



PH-1000

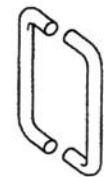

PH-1002



PB-1000



PB-2000

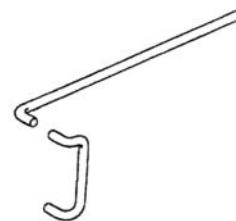

Push/Pull Set
Typical
(Single Bend Push Bar)

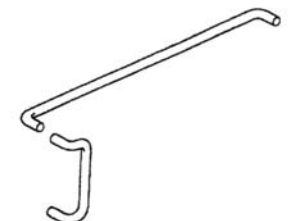

Push/Pull Set
Typical
(Double Bend Push Bar)

Mounting Hardware-3/8 Heavy Duty Bolt is Standard

T1
Thru-Bolt



T6
Concealed



T5
Back-to-Back



Specify: Finish

<< HEAVY DUTY OFFSET/ INTERMEDIATE PIVOT HARDWARE >>

FEATURES

- HD Series heavy duty pivots meet or exceed BHMA/ANSI Grade 1.
- Full mortise with Heavy Duty Needle Bearings standard.
- Cast Brass Material (HD1170 Cast Brass and Steel).
- HDE1900 is non-load bearing with non-separable leaves.
- Industry standard installation templating. Furnished with 1/4-20 x 5/8" Flat Head Machine Screws.
- Standard finishes available: US26, US26D, US3, US4, US10, US10B. Optional finishes by special order.

HD Series
Offset Pivots
Intermediate Pivots

HD1800

- Top Pivot Set
- Non-handed
- 3/4" Offset



HD1950

- Bottom Pivot Set
- Handed Set (LH -or- RH)
- 3/16" Vertical Adjustment
- 3/4" Offset

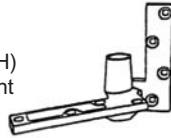

HD1170

- Bottom Pivot Set
- Non-handed
- 3/4" Vertical Adjustment
- 3/4" Offset



HD1950S

- Top & Bottom Pivot Set
- Handed Set (LH -or- RH)
- Jamb Mounted
- BHMA/ANSI C07131/3520

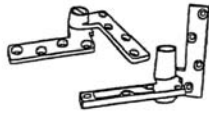

HD1170S

- Top & Bottom Pivot Set
- Non-handed
- Floor Mounted
- BHMA/ANSI C07162/3530A



HD1900

- Intermediate Pivot Set
- Handed (LH -or- RH)
- 3/4" Offset
- BHMA/ANSI C07321/3625

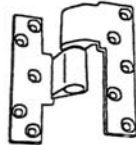

HDE1900

- Electrified Intermediate Pivot Set
- Handed (LH -or- RH)
- 3/4" Offset
- UL Listed wire #28 AWG, Rated 24 volts

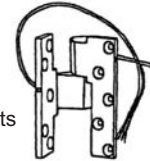

<< HEAVY DUTY OVERHEAD DOOR HOLDERS >>

Calibre 900 Series holders and stops are designed for heavy-duty commercial and institutional applications for high traffic egress. All models are manufactured in 300 series Stainless Steel, offering the highest resistance to corrosion, and Meet or exceed BHMA/ANSI A156.8-2005 standards.

HD 900 Series
Overhead Door Holders/Stops

FEATURES

- Reversible, non-handed units.
- Stop (900S) or Hold-Open (900H) functions.
- On/Off knob on Hold-Open function.
- Surface-mounted channel and jamb bracket
- For Single Acting Center Hung and Offset doors.
- Use with most Surface Applied door closers.
- Standard architectural US32D finish.

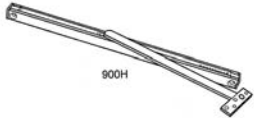
|  | |  | |
|---|-----------------|---|-------------|
| Door Opening | | Stop Only | Hold Open |
| Offset Hung | Center Hung | Set Up # | Part # |
| 28" - 29-15/16" | 30" - 33-15/16" | Set Up #1 | 9001S 9001H |
| 30" - 31-15/16" | 34" - 35-15/16" | Set Up #2 | 9002S 9002H |
| 32" - 35-15/16" | 36" - 38-15/16" | Set Up #3 | 9003S 9003H |
| 36" - 39-15/16" | 39" - 40-15/16" | Set Up #4 | 9004S 9004H |
| 40" - 41-15/16" | 41" - 44-15/16" | Set Up #5 | 9005S 9005H |
| 42" - 43-15/16" | 45" - 46-15/16" | Set Up #6 | 9006S 9006H |
| 44" - and UP | 47" and UP | Set Up #7 | 9007S 9007H |

FASTENER DETAILS

| | QTY | WOOD | METAL |
|--------------|-----|----------------------------|----------------------------|
| JAMB | 4ea | #14 x 1-1/2" F.H.W.S. | 1/4-20 x 3/4" F.H.M.S. |
| DOOR PORTION | 2ea | 5/16-18 F.H.M.S. | 5/16-18 F.H.M.S. |
| | 2ea | 1/2" Diameter Sex Bolts | 1/2" Diameter Sex Bolts |



1481 North Main Street Orange, CA 92867-3403 U.S.A.
TEL: 714/633-5100 • Toll Free: 800/560-0012 • FAX: 714/633-5102

Glass and Aluminum Storefront Door Hardware Product

QUALITY
VALUE
SERVICE

CA/Hardware Series

<< CONTINUOUS GEARED HINGE HARDWARE >>



SL Series

Concealed Hinges
Full Surface Hinges

SL11

- Concealed Hinge
- Flush Mounted
- For 1-3/4" Doors

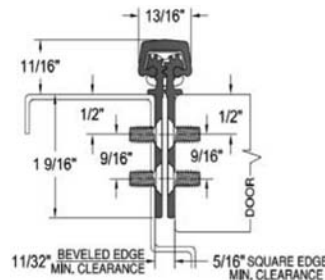

SL24

- Concealed Hinge
- Door Edge Protector
- 1/16" Door Inset
- For 1-3/4" Doors

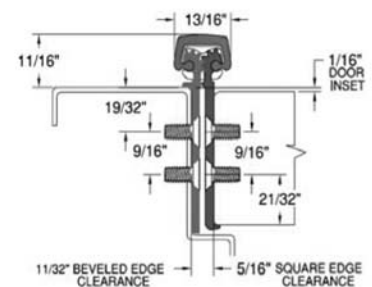

SL21

- Full Surface Hinge
- Swing Clear Function
- 1/32" Door Inset
- For 2" - 2-3/4" doors,
(request long barrel nuts)

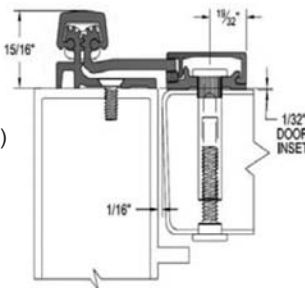

SL57

- Full Surface Hinge
- Narrow (7/8") Frame Face
- Center Pivot Application
- 1/16" Door Inset
- For 2" - 2-3/4" doors
(request long barrel nuts)

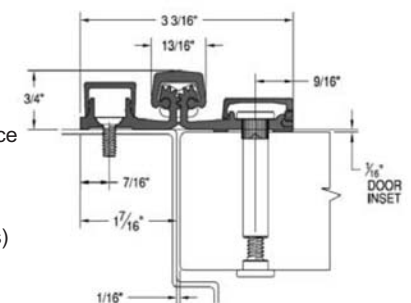

FEATURES

- UL Listed, Certified ANSI A156.25-2006 Grade 1 (25 million cycles), and Certified to 90-minute Fire Rated Standards.
- Manufactured from 6063 T6 aluminum alloy with thermoplastic polyester self-lubricating bearings for extended wear.
- Hinge leaves are Pair-Matched Numbered during manufacturing to assure smooth functioning, and are completely anodized after matching for additional wear resistance and architectural inventory appearance.
- Full-length gears and channel covers prevent tampering for added security. Templated screw hole patterns allow easy preparation for precise fit and interchange if required.
- Non-handed hinge design prevents installation mistakes, and keeps inventory to a minimum.
- Standard finishes available: **CL** - Aluminum / **DU** - Storefront Bronze. Optional finishes by special order.
- Standard Hinge lengths available: 83", 95", and 120" (with 120° generally available by special order).

Continuous Gear Hinges

Cross Reference Sheet

| Hinge Series | Calibre Select | Pemko | Roton | ABH |
|--|----------------|-------|---------|------|
| Full Concealed, Flush Mount | SL11 | FMSLF | 780-112 | A110 |
| Full Concealed, 1/8" Door Inset | SL18 | FMSLI | 780-111 | A111 |
| Full Concealed, 1/16" Door Inset | SL24 | FM | 780-224 | A240 |
| Full Surface, 1/32" Door Inset (Swing Clear) | SL21 | FS | 780-210 | A210 |
| Full Surface, 1/16" Door Inset (Narrow Frame) | SL57 | FSCP | 780-157 | A570 |

How to Order Calibre / Select Hinges:

Example: SL57-83-DU-SD

SL57 Hinge Series (Full Surface, 1/16" Door Inset)
 83 Hinge Length (83", 85", 95", and 120")
 DU Hinge Finish (CL Clear Aluminum, DU = Dark Bronze)
 SD Hinge Type (SD Standard Duty, HD = Heavy Duty)

Glass and Aluminum Storefront Door Hardware Product

**QUALITY
VALUE
SERVICE**

CA/Exit Devices

<< PANIC EXIT DEVICE HARDWARE >>

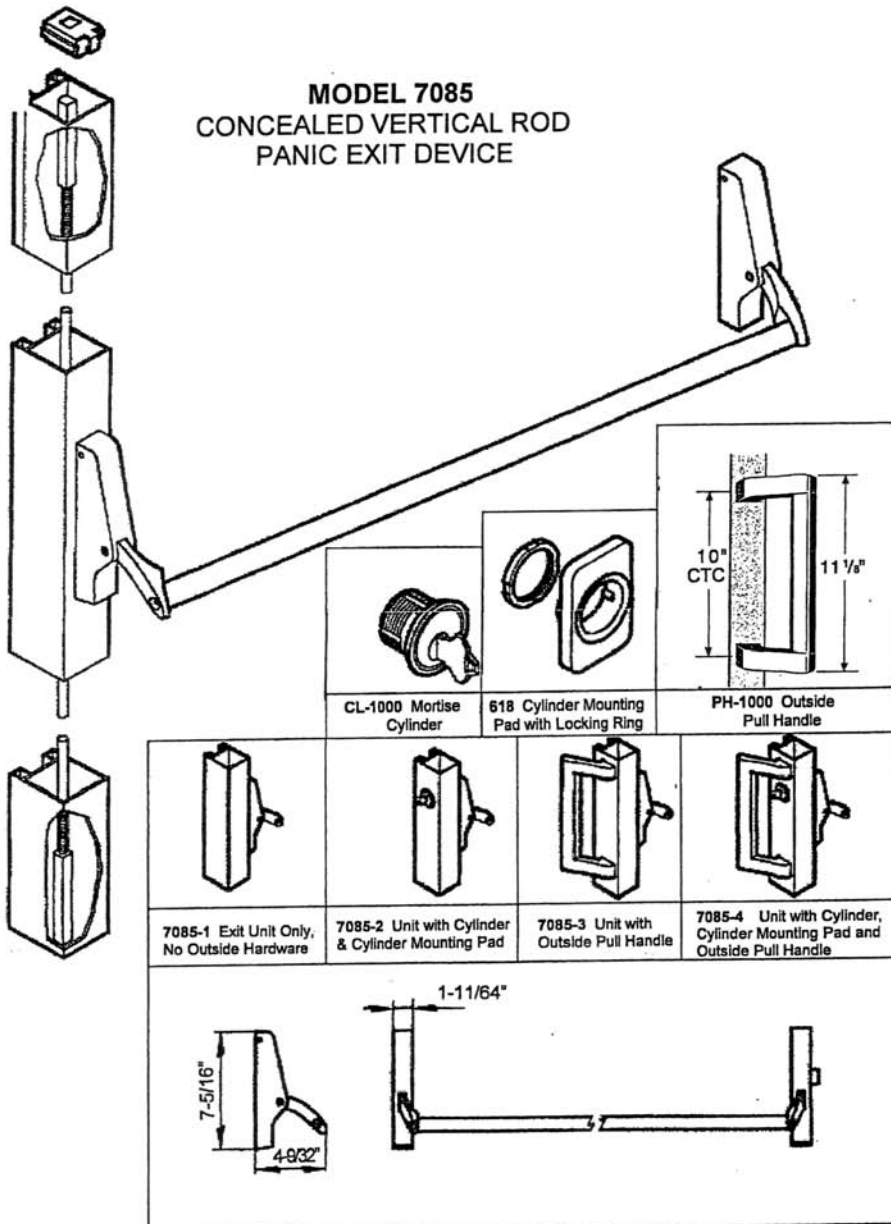

FEATURES

- Underwriters' Laboratories Inc. Listed - Panic Hardware.
- For use with Narrow, Medium, and Wide Stile Aluminum Doors.
- Non-Handed for LHRB or RHRB doors..
- Dogging by Cylinder Key or by slotted Dogging Screw in bottom of each Pad Assembly.
- Unit uses standard Mortise Cylinder with MS type Cam and Cylinder Mounting Pad with Locking Ring.
- Fits doors up to 48" in width (cut Cross Bar to fit).
- Unit installs using (2) 1/4-20 concealed Shoulder Studs.
- Anodized Aluminum Cross Bar.
- Finishes Available:
AL - Aluminum
DU - Storefront Bronze

<< PANIC EXIT DEVICE HARDWARE >>

MODEL 7095
RIM TYPE
PANIC EXIT DEVICE

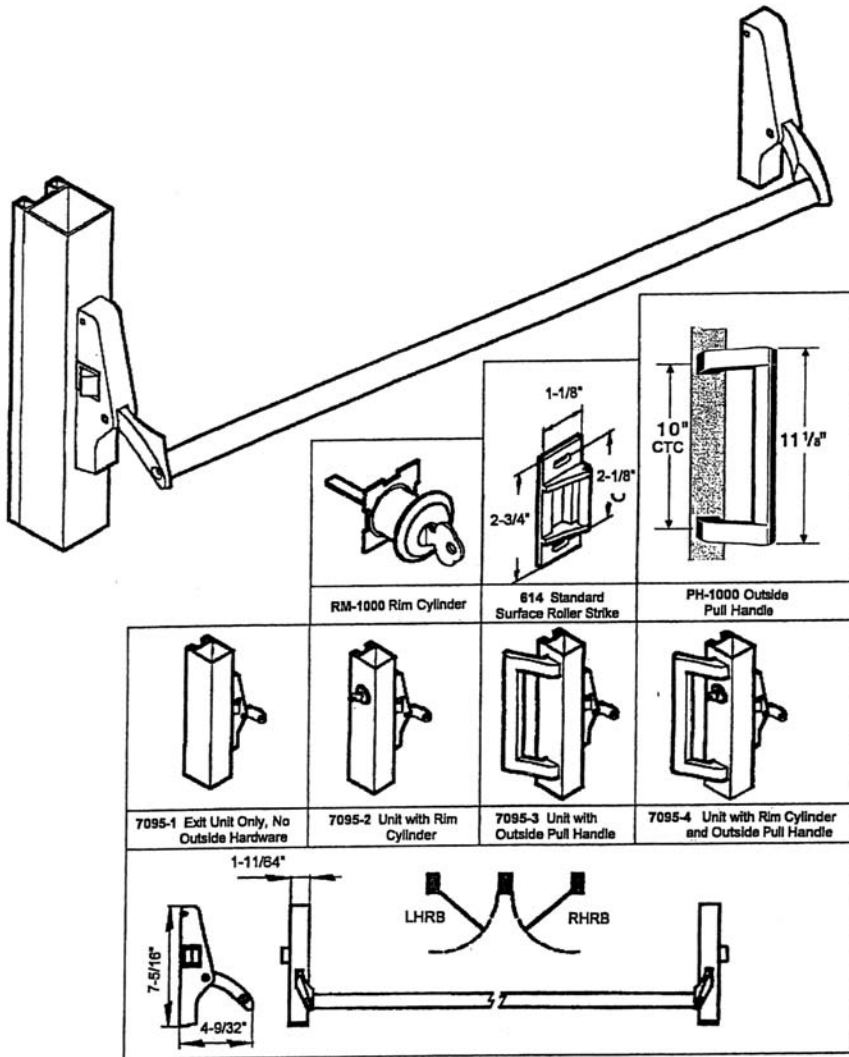

FEATURES

- Underwriters' Laboratories Inc Listed - Panic Hardware.
- For use with Narrow, Medium, and Wide Stile Aluminum Doors.
- Handed - Specify for LHRB or RHRB door.
- Dogging by Cylinder Key or by slotted Dogging Screw in bottom of each Pad Assembly.
- Unit uses standard Rim type Cylinder.
- Latch Bolt throw 1/2".
- Includes standard 614 Roller Strike.
- Fits doors up to 48" in width (cut Cross Bar to fit).
- Unit installs using (2) 1/4-20 concealed Shoulder Studs.
- Anodized Aluminum Cross Bar
- Finishes Available:
 - AL - Aluminum
 - DU - Storefront Bronze

Glass and Aluminum Storefront Door Hardware Product

CA/Exit Devices

**QUALITY
VALUE
SERVICE**

<< PANIC EXIT DEVICE HARDWARE >>

9100 Series Narrow Stile Flat Bar Concealed Vertical Rod Exit Device

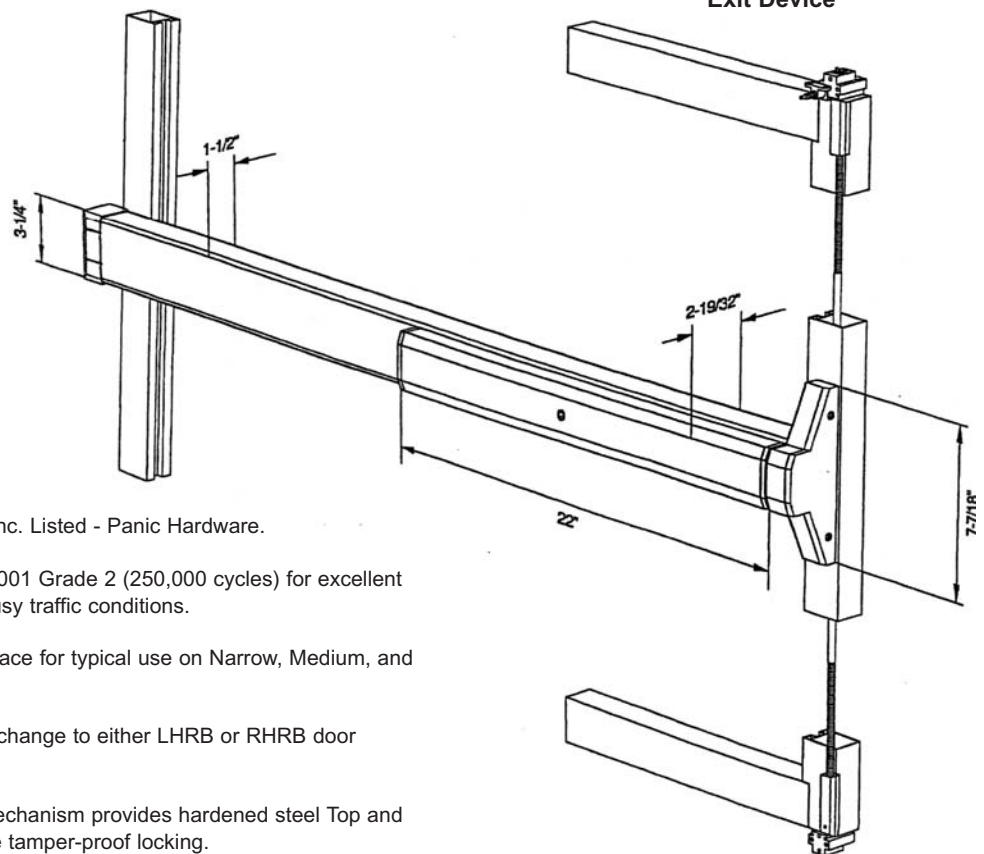

FEATURES

- Underwriters' Laboratories Inc. Listed - Panic Hardware.
- Conforms to ANSI A156.3-2001 Grade 2 (250,000 cycles) for excellent security and durability for busy traffic conditions.
- Requires a 2" mounting surface for typical use on Narrow, Medium, and Wide Stile Aluminum Doors.
- Field Reversible - For easy change to either LHRB or RHRB door applications.
- 9100 Series internal Rod Mechanism provides hardened steel Top and Bottom Rod Bolts for secure tamper-proof locking.
- Push Bar and Casing are 6063 hardened anodized aluminum with a steel Back Plate base, and the solid metal End Caps are coated for an attractive, long lasting finish.
- Outside Unlatching and Dogging by Mortise Cylinder Key, or Dogging by Hex Key (furnished) in the Touch Bar.
- Specify for 36" or 48" door width.
- Finishes available:
 - AL - Aluminum
 - DU - Storefront Bronze

9300 Series
Narrow Stile Flat Bar
Rim Latching
Exit Device

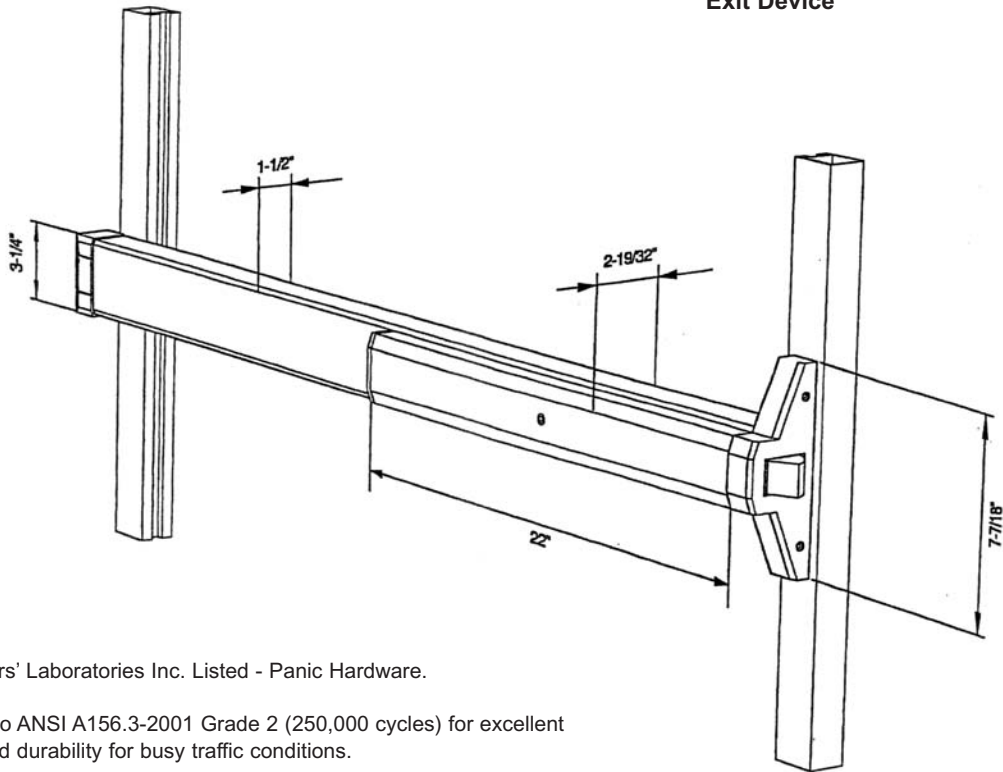

FEATURES

- Underwriters' Laboratories Inc. Listed - Panic Hardware.
- Conforms to ANSI A156.3-2001 Grade 2 (250,000 cycles) for excellent security and durability for busy traffic conditions.
- Requires a 2" mounting surface for typical use on Narrow, Medium, and Wide Stile Aluminum Doors, or for use on Hollow Metal and Wood Doors.
- Non-Handed - For use on either LHRB or RHRB door applications.
- 9300 Series utilizes a 1" forged steel Latch Bolt with a 5/8" throw to engage the frame mounted Roller Strike.
- Push Bar and Casing are 6063 hardened anodized aluminum with a steel Back Plate base, and the metal End Caps are coated for an attractive, long lasting finish.
- Dogging by Hex Dogging Key (furnished) in the touch bar. Outside unlatching with standard external key Rim Cylinder.
- Specify for 36" or 48" door width.
- Finishes available:
 - AL - Aluminum
 - DU - Storefront Bronze